

DASHER® D411 and D461 DISPLAY TERMINALS USER'S MANUAL

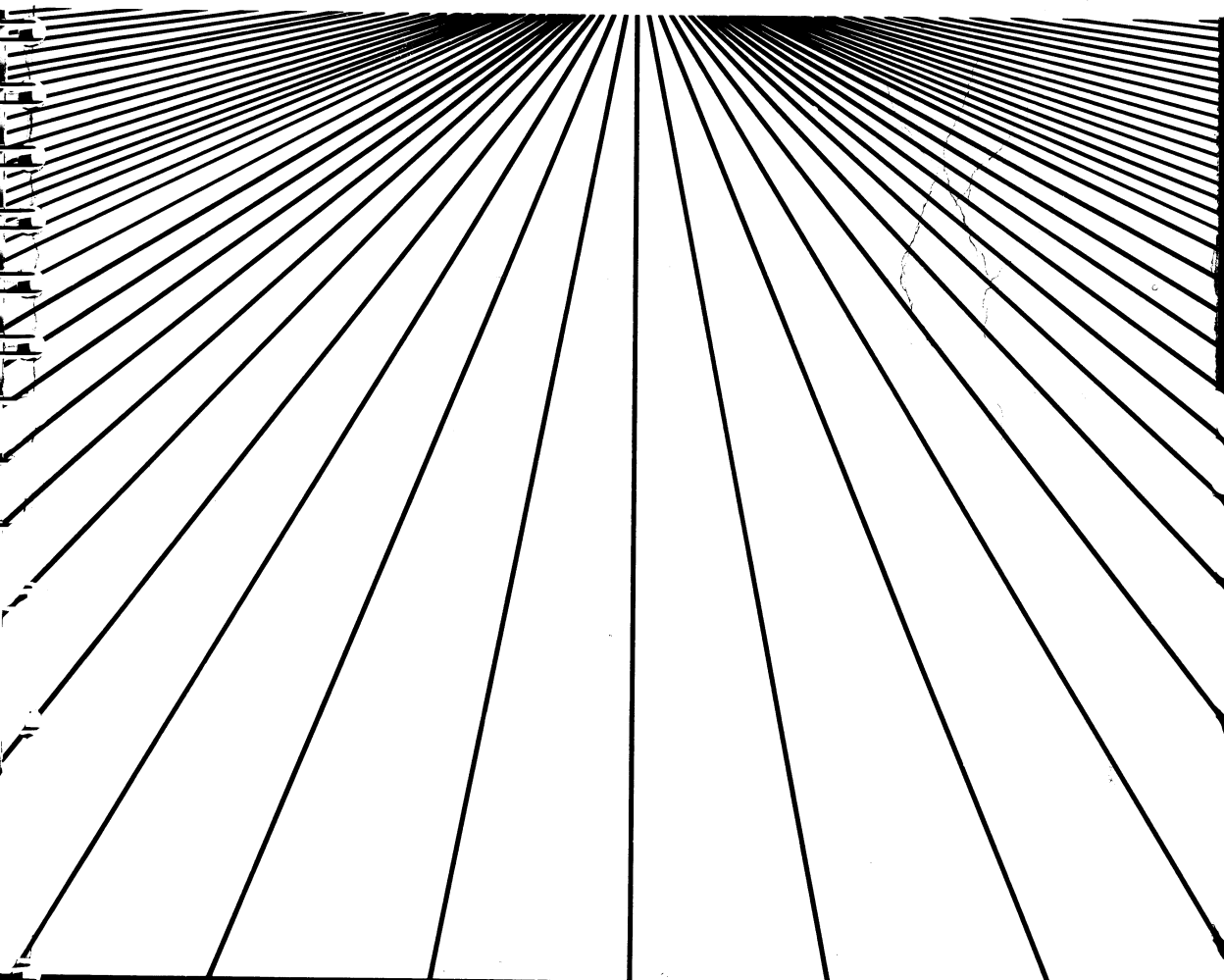

Technical Specifications

Functional

Display Unit	Tabletop, tiltable mounting; 305-mm (12-in.) diagonal screen with 211-mm (8.3-in.) by 150-mm (5.9-in.) viewing area; 24 lines by 81 characters per line or 24 by 135 characters per line
Keyboard	Low-profile, independent tabletop mounting with sculptured keys; multi-key rollover; typematic and manual repeat; 5 basic keypad groups; on-line, alpha-lock, and hold lamps
Screen Phosphor	Amber or P31 green
Screen Refresh Rate	60 frames per second (domestic 60 Hz), 50 frames per second (foreign 50 Hz)
Display Technique	Noninterlaced raster
Characters	10 x 12 dot-matrix character cell
Character Sets	U.S., U.K., French, German, Swedish/Finnish, Spanish, Danish/Norwegian, Swiss, DG International, Katakana and word processing, math, line drawing, and superscript/subscript symbols
Display Scrolling	One-row increments (jump scrolling), or smooth at 5 rows per second or 10 rows per second
Self-Test	On power-up, program verifies terminal is operational

Communication

Interface Types	Asynchronous serial, full-duplex; RS-232-C; RS-422-A or 20-mA current loop; Xon/Xoff protocol
Baud Rates	110, 150, 300, 600, 1,200, 1,800, 2,400, 4,800, 9,600, and 19,200 baud (EIA RS-232-C and RS-422-A; 110-9,600 (20-mA))
Data Format	ASCII; 7- or 8-bit characters; mark, even, odd, or no parity; one stop bit DG or ANSI (switch selectable)
Printer Baud Rate	Second interface for serial ASCII-based or graphics dot-matrix printer; EIA RS-232-C compatible; 110, 150, 300, 600, 1200, 1800, 2400, 4800, 9600, and 19200 baud.

Physical

Display Unit Dimensions	Height: 34 cm (13.1 in.); Depth: 32.7 cm (12.8 in.); Width: 32.7 cm (12.8 in.)
Keyboard Dimensions	Height: 4.4 cm (2.4 in.); Depth: 19.6 cm (7.5 in.); Width: 51.9 cm (20 in.)

(Technical Specifications are continued on the inside back cover.)

DASHER® D411 and D461 DISPLAY TERMINALS USER'S MANUAL

WARNING: This equipment generates, uses, and can radiate radio frequency energy and, if not installed and used in accordance with the instruction manual, may cause interference to radio communications. It has been tested and found to comply with the limits for Class A computing devices pursuant to Subpart J of Part 15 of FCC Rules, which are designed to provide reasonable protection against such interference when operated in a commercial environment. Operation of this equipment in a residential area is likely to cause interference, in which case the user, at his own expense, will be required to take whatever measures may be required to correct the interference.

Notice

Data General Corporation (DGC) has prepared this document for use by DGC personnel, customers and prospective customers. The information contained herein shall not be reproduced in whole or in part without DGC's prior written approval.

DGC reserves the right to make changes in specifications and other information contained in this document without prior notice, and the reader should in all cases consult DGC to determine whether any such changes have been made.

THE TERMS AND CONDITIONS GOVERNING THE SALE OF DGC HARDWARE PRODUCTS AND THE LICENSING OF DGC SOFTWARE CONSIST SOLELY OF THOSE SET FORTH IN THE WRITTEN CONTRACTS BETWEEN DGC AND ITS CUSTOMERS. NO REPRESENTATION OR OTHER AFFIRMATION OF FACT CONTAINED IN THIS DOCUMENT INCLUDING BUT NOT LIMITED TO STATEMENTS REGARDING CAPACITY, RESPONSE-TIME PERFORMANCE, SUITABILITY FOR USE OR PERFORMANCE OF PRODUCTS DESCRIBED HEREIN SHALL BE DEEMED TO BE A WARRANTY BY DGC FOR ANY PURPOSE, OR GIVE RISE TO ANY LIABILITY OF DGC WHATSOEVER.

IN NO EVENT SHALL DGC BE LIABLE FOR ANY INCIDENTAL, INDIRECT, SPECIAL OR CONSEQUENTIAL DAMAGES WHATSOEVER (INCLUDING BUT NOT LIMITED TO LOST PROFITS) ARISING OUT OF OR RELATED TO THIS DOCUMENT OR THE INFORMATION CONTAINED IN IT, EVEN IF DGC HAS BEEN ADVISED, KNEW OR SHOULD HAVE KNOWN OF THE POSSIBILITY OF SUCH DAMAGES.

CEO, DASHER, NOVA, microNOVA, and ECLIPSE are U.S. registered trademarks of Data General Corporation.

Ordering No. 014-001161
Copyright © Data General Corporation, 1985
All Rights Reserved
Printed in Thailand
Rev. 01, March 1986

Preface

This *DASHER® D411 and D461 Display Terminal User's Manual* provides an overview of the terminal's features and contains installation and operating instructions. This manual is divided into chapters and appendixes as follows:

Chapter/ Appendix

- 1 Product Overview — Introduces features and capabilities of both models of the terminal.
- 2 Installation — Provides the site requirement, repacking, installation, and checkout instructions for the terminal.
- 3 Operation — Describes the terminal controls and indicators with emphasis on the keyboard; includes terminal operating procedures that are independent of the host computer, and closes with a short paragraph on operator maintenance.
- A Display Screen Format and Coordinate System
- B ASCII D411/D461 Code Sequences
- C Summary of D411/D461 Commands
- D D411/D461 Argument Formats
- E D411/D461 U.S. ASCII Functions and Conversions
- F D411/D461 ANSI Modes of Operation

Related Publications

The following documentation contains additional information on the DASHER D411 and D461 Display Terminals:

- *DASHER D411 and D461 Display Terminal Programmer's Reference Manual*, ordering number 014-001162
- *DASHER D411 and D461 Display Terminal Installation Data Sheets*, ordering number 010-001126

How To Use This Manual

Users unfamiliar with the capabilities of the D411/D461 terminal will want to begin with Chapter 1, the product overview. Since the best way to learn about your terminal is through hands-on experience, refer to Chapter 2 for installation instructions to get your terminal up and running. The checkout procedures in Chapter 2 will help you determine if your terminal is working properly.

Finally, turn to Chapter 3 for operation instructions.

This manual is carefully indexed for your convenience. Seek help in the index, at the back of the manual, if you have trouble locating specific information. You will also find the glossary useful in defining unfamiliar terms.

Appendixes A, B, C, and D contain abbreviated programming information. If you plan to write host-resident software for the D411/D461 terminal and need more detailed programming information, refer to the *DASHER D411/D461 Display Terminal Programmer's Reference Manual*.

Contents

Chapter 1 Product Overview

Introduction	1-1
Product Features	1-2
Display-Screen Management	1-3
Windows	1-4
Character Spacing	1-5
Display Scrolling	1-5
Margins	1-6
Editing Functions	1-6
Character Attributes	1-7
Command Syntax Modes	1-7
Character Sets	1-8
Print Methods	1-9
Extended Character Set	1-10
Product Description	1-11
Display Unit	1-14
Keyboard	1-15
System Operation Overview	1-18
On-Line Operation	1-18
Off-Line Operation	1-20

Chapter 2 Installation and Maintenance

Introduction	2-1
Site Requirements	2-1
Repacking	2-2
Installation	2-2
Operational Checkout	2-16
Self-Test and Off-Line Checkout	2-17
On-Line Checkout	2-23
Off-Line Printer Checkout	2-23
User Maintenance	2-24

Chapter 3 Operation

Introduction	3-1
Display Unit Controls and Indicators	3-1
Terminal Power-Up/Power-Down Procedures	3-3
Power-Up Procedure	3-3
Power-Down Procedure	3-3
Terminal Operating Procedures	3-4
On-Line Operation	3-4
Off-Line Operation	3-4
Keyboard Controls and Indicators	3-6
Main Keypad	3-8
Screen-Management Keypad	3-13

User-Function Keys	3-16
Numeric Keypad	3-16
Local-Function Keys	3-16
Mouse and Digitizer Operation	3-21
Downloading User-Defined Character Sets	3-22

Appendix A
Display Screen Format and Coordinate System

Display Screen Row/Column Format	A-1
Display Screen Coordinate System	A-1

Appendix B
ASCII D411/D461 Code Sequences

ASCII D411/D461 Code Sequences (Data General Operation)	B-1
ASCII D411/D461 Code Sequences (ANSI Operation)	B-3

Appendix C
Summary of D411/D461 Commands

Appendix D
D411/D461 Argument Formats

Command/Argument Formats in Data General Mode	D-1
Graphics Location/Height/Width Arguments	D-2
Select Character Set Command Arguments	D-3

Appendix E
D411/D461 U.S. ASCII Functions and Conversion

Appendix F
D411/D461 ANSI Modes of Operation

Glossary

Index

Figures

1-1	DASHER D411/D461 Display Terminal	1-2
1-2	Display-Screen Memory	1-5
1-3	D461 Terminal Graphics	1-11
1-4	D411/D461 Terminal System Configuration	1-14
1-5	D411/D461 Terminal Keyboard Layout	1-17
1-6	D411/D461 Terminal and Host Computer Operation	1-19
2-1	Rear View of D411/D461	2-3
2-2	Rear View and Connectors of the D411 and D461 ..	2-4
2-3	Data General EIA RS-232-C Terminal Interface	2-7
2-4	RS-422-A Host/Controller Cable	2-8
2-5	Termination Details for Non-DG Shielded Cables ..	2-9
2-6	Data General 20-mA Current Loop Terminal Interface	2-10

2-7	Menu for Terminal Communication Option Settings	2-13
3-1	Display-Unit Contrast Control	3-2
3-2	Terminal Keyboard	3-6
3-3	Main Keypad	3-8
3-4	Screen-Management Keypad and User-Function Keys	3-14
3-5	Numeric Keypad and Local-Function Keys	3-17
3-6	Print Menu	3-19

Tables

1-1	Foreign Language Character Sets	1-8
1-2	D411/D461 Print Methods for Data General Syntax	1-9
1-3	D411/D461 Terminal Component Model Numbers	1-12
1-4	Keyboards Supported by the D411/D461 Terminal	1-16
2-1	D411/D461 Default Terminal Configurations Settings	2-12
2-2	Enabling Terminal Configuration Menu Settings	2-15
2-3	Terminal Off-line Checkout And Demonstration Procedure	2-17
2-4	Terminal Problem Diagnosis	2-25
3-1	SPCL Key Sequences	3-11
3-2	Terminal Reset Conditions	3-15
B-1	ASCII D411/D461 Code Sequences (Data General Operation)	B-2
B-2	ASCII D411/D461 Code Sequences (ANSI Operation)	B-4
C-1	D411/D461 Commands in Alphabetical Order (DG Operation)	C-1
C-2	D411/D461 Commands in Octal Code Order (DG Operation)	C-7
C-3	D411/D461 Commands in Alphabetical Order (ANSI Operation)	C-11
C-4	D411/D461 Commands in Octal Code Order (ANSI Operation)	C-14
D-1	Command Argument Format (DG Mode)	D-1
D-2	Graphics Location/Height/Width Arguments	D-2
D-3	Select Character Set Command Arguments	D-3
E-1	D411/D461 ASCII Functions and Conversion	E-2
F-1	D411/D461 Fixed ANSI Modes of Operation	F-1
F-2	D411/D461 Selectable ANSI Modes of Operation	F-2

Chapter 1

Product Overview

This chapter provides an overview of the D411/D461 Display Terminal. The information in this chapter is organized as follows:

- Product features
- Product description
- System operation overview

Introduction

The DASHER® D411 and D461 Display Terminals (Figure 1-1) are desk-top, 12-inch, green or amber monochrome terminals containing many advanced features that combine to improve productivity in a business or dataprocessing environment. These features include four separate operating modes, display-screen windows, bidirectional vertical and horizontal scrolling, built-in editing functions, 81- and 135-column character viewing, protected character fields, a printer/mouse/digitizer port, etc.

The D461 terminal is identical to the D411 terminal with one major addition: the D461 includes a downline loadable (DLL) memory or soft character set feature that provides for user-defined characters and basic drawing functions that make the display and printing of graphics possible. Both the D411 and D461 terminals are intended to be connected to any host computer system that supports full-duplex communications via a 20 mA current loop or EIA RS-232-C compatible interface and uses Xon/Xoff protocol. An EIA RS-422 interface is provided as an alternative to current loop for long lines. This interface does not conform to the associated RS-449 mechanical standard. The terminal's EIA RS-232-C interface can be used at a remote site in conjunction with Bell 103, 113, or 212 compatible modems and an available telephone system.

Throughout this manual, the term D411/D461 terminal is used whenever the current topic is common to both the D411 and D461 terminals.

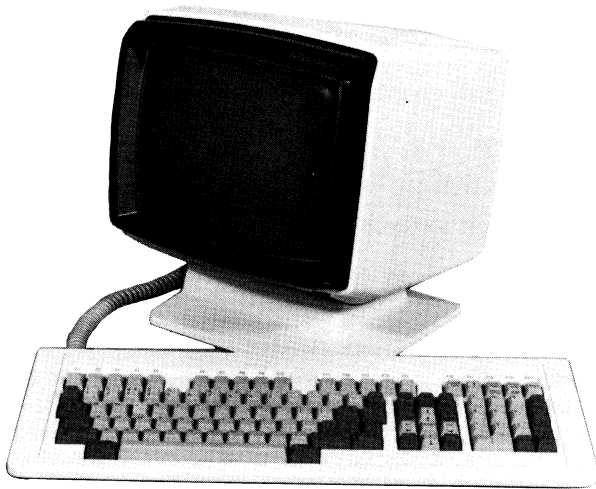

Figure 1-1. Dasher D411/D461 Display Terminal

Product Features

The basic D411/D461 terminal consists of a CRT display unit and a keyboard as shown in Figure 1-1. The display unit, mounted on a tiltable base, and the detached, sculptured keyboard combine to provide maximum flexibility in viewing and keyboard access for the operator.

The D411/D461 terminal can be configured in a United States version, two Canadian versions, a Japanese version, or in eight European versions. It offers the option of operating in either Data General command syntax or in the American National Standards Institute's (ANSI) standard command syntax. The terminal can operate in four different command syntax modes: two of the modes are compatible with previous command sets used with Data General display terminals, and the other two meet ANSI standards. A special key provides, in three

of the four modes, the option of conveniently creating any of 45 different international characters immediately, regardless of keypad nationality.

The D411/D461 terminal introduces three important features to the Data General D400 series of terminals. First, terminal communication options such as baud rate, data bits and parity are set from the keyboard rather than by DIP (dual-in-line package) switches. The possible settings for the communication options are presented in a menu called up on the screen by simultaneously pressing the CMD and N/C keys. Second, the D411/D461 terminal has a screen-saver feature called "Auto Screen Dim." This feature automatically blanks the screen 15, 30, 45, or 60 minutes after reset or after the last key has been struck. Third, the D411/D461 offers integral support for the Japanese Katakana character set. This means that, unlike the D410/D460 terminal, a separate Katakana version of the display unit is not needed to use this character set.

The next few sections highlight the more important features of the D411/D461 terminal. Keep in mind that the D411/D461 terminal, which includes significant advances over the D400/D450 terminal, is also compatible with the DASHER D200 Display Terminal. This allows you to disconnect a D200 terminal and replace it with the D411/D461 without making hardware or software changes. You can then take advantage of the added features of the D411/D461 as your current software is modified or replaced.

All of the features described in the next few pages are programmable. That is, they can be exercised on command from a host computer. The D411/D461 terminal command set is both versatile and easy to use, simplifying the implementation of terminal features in various applications. Some of the features can be controlled directly from the keyboard. These features will be pointed out as they are discussed.

Display-Screen Management

The screen-management capabilities of the D411/D461 terminal are listed below.

- Up to 24 scroll areas, or windows
- Normal (81-column) and compressed (135-column) character viewing (spacing)
- Programmable margins

- Vertical (bidirectional) smooth scrolling
- 208-column horizontal scrolling
- Graphics cursor for graphics-input devices such as mouse and digitizer (D461 only)

Windows

When the D411/D461 terminal is turned on, the display screen is organized into 24 character rows with 80 character positions in each row. The window feature makes it possible to divide the full screen into multiple miniature screens along character row boundaries. Each window is formed by a consecutive number of character rows. The smallest window may consist of one row and the largest window may consist of 24 rows.

Only one of the windows on the display screen is treated as “active” or “current.” This is the window you are working on at the time. The other windows are inactive, and may display data from the same file or from different files. You’ll find the window feature helpful for separating areas of a form, for comparing the contents of two or more data files, or in any application where you need display-screen segregation.

The active window contains the display-screen alphanumeric cursor. The cursor marks the position on the display screen that will hold the next character for display from either the host computer or the user at the keyboard. The host computer can easily reassign the active window by moving the cursor across window boundaries.

Character Spacing

The D411/D461 terminal is equipped with an extended display screen memory that contains 208 characters in each of the 24 rows, as shown in Figure 1-2. You can select normal (81-column) or compressed (135-column) character viewing (spacing) on a screen basis. Normal character spacing is similar to that of the earlier Model D200 terminal, and allows you to build 2-1/2 full screens of data side by side in display-screen memory. Compressed character spacing will let you view all columns of a wide form (up to 135 columns) at one time.

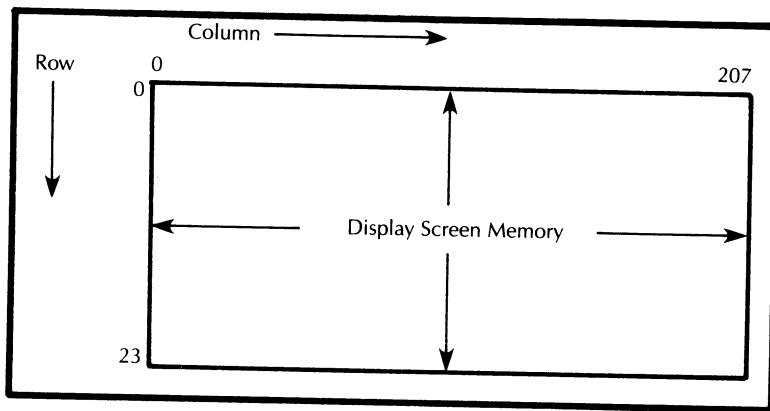

AA-0601

Figure 1-2. Display-Screen Memory

Display Scrolling

Left and right horizontal scrolling of the active window lets you see all 208 columns of the display-screen memory. You can scroll vertically both up and down in the window in three styles: slow and fast smooth, and fast jumpy. Each style is both keyboard-selectable and command-selectable. Slow smooth scrolling rolls the screen up or down at the rate of 5 character rows (60 raster lines) per second, fast smooth or jumpy scrolling at 10 character rows (120 raster lines) per second. You can halt

and resume vertical scrolling at any time from the keyboard. Smooth scrolling coupled with screen freeze makes it easy for you to scan or read through information on the screen.

Margins

The active window combines with the programmable margins feature to define the working area on the display screen. Window boundaries are the upper and lower boundary lines running across the display screen at the top and bottom of each window; margins are the left and right boundary lines. Movement of the display-screen cursor is restricted to the area between the margins in the active window. Attempting to position the cursor beyond the edge of a window results in the cursor pegging at the margin. The margin settings extend across window boundaries; this means only one set of margins is in effect at any time. An alternate margin feature makes it possible to assign a second set of margins while saving the normal margins for future use.

When the D411/D461 terminal is turned on, the left and right margins are set to columns 0 and 79, respectively. You can reset the margins easily under host computer control to any of the columns in the range of 0 to 207. The only restriction on margin assignment is that the left margin column number be no greater than the right margin column number. When the left and right margins are the same, the working area in the active window is one column wide.

Editing Functions

The D411/D461 terminal includes special built-in editing features that provide for easy and fast reorganization of characters on the display screen. Highlights of the editing features include:

- Insert/delete individual characters or complete lines. This feature cuts down on host/terminal character traffic by making these editing operations possible without rewriting part or all of the display screen.
- Besides the conventional screen- and line-erase capabilities, the D411/D461 terminal is equipped with window-erase and unprotected-text-erase commands. These commands complement the window and protected text features of the terminal.

Character Attributes

Every character position on the display screen has four display attributes plus a protect attribute.

The display attributes are valuable for character highlighting. Each character displayed on the screen can be underscored, dimmed, made to blink, or displayed in reverse-video form independently of all other characters. These four attributes can be applied in all combinations. A special feature allows you to change with one command the display attributes for all characters in the active window.

When on, the protect attribute prevents the destruction of a character field by the keyboard operator using normal cursor-related commands. The cursor will skip over protected characters on the screen, so that critical character fields (fixed information on a form, for example) are preserved. You can delete protected text with the Erase Screen or Erase Window commands, which are generally restricted to the host computer's use.

Command Syntax Modes

The Data General D411/D461 terminal offers the choice of four modes of command syntax operation: Data General 7-bit, Data General 8-bit, ANSI 7-bit, and ANSI 8-bit. These modes, along with other terminal communication options, are selected via the Terminal Configuration menu accessed by pressing the CMD and N/C keys simultaneously. The terminal will be configured with default settings at the factory. These are values that will be assigned automatically unless you make another selection. Upon power-up or when the terminal goes on-line, the terminal will default to DG 8-bit mode. See Chapter 2 for default values for all the communication options and for details on setting these parameters. Software switches override both the Data General/ANSI setting and the 7- or 8-bit-mode setting so the command syntax mode can be changed dynamically by the host system. This feature maintains the terminal's compatibility with existing OS (Operating System) support for Data General terminals while allowing use of industry-standard code sequences involving ANSI 3.4, 3.41, and 3.64 environments.

Character Sets

The character sets available for the D411/D461 terminal are:

- United States ASCII
- Foreign language character sets (see Table 1-1)
- Greek alphabet subset
- Extended math symbols
- Line-drawing character set
- Word-processing symbols
- Superscripts and subscripts

Any of these character sets can be selected for display on command from the host computer.

Table 1-1. Foreign Language Character Sets

U.K.	Spanish
French	Danish/Norwegian
German	Swiss
Katakana	Data General International
Swedish/Finnish	

When the terminal is powered up, your display unit senses the nationality of the keyboard and selects the matching character set for display. This is a default selection, however, and you retain the option of selecting any of the other character sets.

The line-drawing character set is not the same as the graphics-drawing features of the D461 terminal that will be discussed later in this chapter. The line-drawing character set makes it possible for you to build a simple graphics image by positioning line-drawing symbols in selected patterns on the screen.

Print Methods

The D411/D461 terminal supports local, ASCII-based serial printers.

Table 1-2 shows the six different print methods available in the Data General mode on the D411/D461 terminal and the commands supported by each. See your programmer's reference manual for details about each command.

Table 1-2. D411/D461 Print Methods for Data General Syntax

Method	Commands Supported
ASCII text	Print Window Print Form
Bit-image screen dump test	Window Bit Dump Form Bit Dump
ASCII print pass through	Print Pass Through
ASCII Simulprint	ASCII Simulprint

The standard ASCII character sets for the U.S. and the sets for the other countries mentioned earlier can be printed using commands under the ASCII text method. User-defined characters and the special-symbol character sets (those containing the word-processing, math, Greek alphabet, superscript/subscript, and line-drawing symbols) can be printed using commands under the Bit Image Screen Dump method if a graphics serial printer is connected. User-defined characters, discussed in the next section, are unique to the D461 terminal. In the ASCII Print Pass Through method, all characters received over the host link are transmitted to the printer without being displayed on the terminal screen. In the ASCII Simulprint method, all characters received over the host link are transmitted to the printer and simultaneously displayed on the screen.

Similar printing functions can be obtained using a command in ANSI mode; the Media Copy command used in conjunction with either the set or reset state of the Forms mode and the Guarded Area Transfer mode initiates printing and controls the print method. A variation of this same command causes a bit-image dump to be sent to the printer.

As explained earlier, the margins for the D411/D461 terminal can be set to a maximum width of 208 columns (character positions), so the D411/D461 terminal can produce lines of up to 208 characters long. Whether lines of this length can be printed depends upon the capabilities of the printer.

Extended Character Set

The D461 terminal includes an extended character set, downline loadable (DLL) memory not included with the D411 terminal. The DLL memory can store up to 3,572 user-defined or custom character definitions at any one time. These 3,572 characters are grouped into 38 sets of 94 characters each. When the D461 terminal is turned on, these 38 character sets do not contain any custom characters. To install custom characters in the terminal, you must download (transfer) their definitions from the host computer.

After you have downloaded one or more custom character sets, you may select the custom sets for display or printing just like the standard character sets in the D411 terminal. Custom characters can be displayed with normal and compressed character spacing.

The DLL feature can also be used by the D461 terminal to produce graphics. A graphic image is developed using two basic drawing elements: straight lines and bars (solid rectangles). The bars are either all green (amber on Model 6347A) or all black; the lines can be solid green or amber, solid black, dashed, dotted, or any pattern of green or amber, and black desired. The drawing algorithms in the terminal define their own custom characters in the DLL character sets and combine the custom definitions on the screen to draw the desired lines and bars. Figure 1-3 shows an example of how line segments can be combined to produce effective business charts.

The graphics cursor, available on the D461 terminal, is a positioning device used to select particular picture elements (pixels) on the screen. The easiest way to control the movement of the cursor is via a mouse or digitizer. An alternate way, however, is with the cursor-control keys on the keyboard. The Cursor Tracking command allows you to select the method of cursor control.

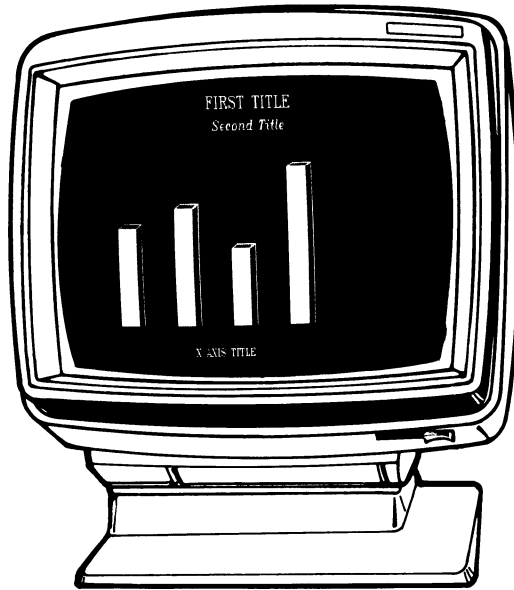

AA-0602

Figure 1-3. D461 Terminal Graphics

Product Description

The basic D411/D461 terminal system consists of the following major components:

- Display unit
- Keyboard (and cable)
- Host/terminal interface cable*

*Ordered separately.

Table 1-3 lists the model numbers for the D411/D461 terminal components. The display-unit model number includes a numeric suffix that defines the power configuration. The keyboard model number includes a suffix character defining the primary nationality. Notice that Table 1-3 shows numerous keyboard nationalities but no display-unit nationality. When the D411/D461 terminal is powered up, the display

unit senses the nationality of the keyboard and automatically displays the matching character set.

Figure 1-4 shows the configuration of a D411/D461 terminal connected to a host computer system.

Table 1-3. D411/D461 Terminal Component Model Numbers

Component	Model	Description		
D411 Display Unit	6346 6346A	Green screen phosphor Amber screen phosphor		
D461 Display Unit	6347 6347A	Green screen phosphor, downloadable character sets Amber screen phosphor, downloadable character sets		
D411 and D461 Display Units	All	Suffix	Voltage	For Use In
		None	120 Vac 60 Hz	Antilles, Canada, Bolivia, Brazil, Chile, Colombia, Costa Rica, Dominican Republic, Ecuador, Guatemala, Haiti, Honduras, Korea, Mexico, Nicaragua, Panama, Paraguay, Peru, Philippines, Taiwan, Trinidad, Venezuela, Uruguay, United States Japan
		-1	100 Vac 50-60 Hz	
		-2	220 Vac 50 Hz	(No power cord supplied)
		-4	240 Vac 50 Hz	(No power cord supplied)
-5	240 Vac 50 Hz	Belize, Bermuda, British West Indies, Hong Kong, Ireland, Malaysia, Nigeria, Singapore, U.A.R., United Kingdom, Scotland, N. Ireland, Wales		

**Table 1-3. D411/D461 Terminal Component Model Numbers
(continued)**

Ergonomic Keyboard	6348	-6	240 Vac 50 Hz	Australia, New Zealand
		-7	220 Vac 50 Hz	Austria, Belgium, Finland, France, Germany, Greece, Iceland, Indonesia, Iran, Luxembourg, Netherlands, Norway, Portugal, Spain, Sweden
		-8	220 Vac 50 Hz	Italy
		-9	220 Vac 50 Hz	Denmark, Greenland
		-0	220 Vac 50 Hz	Switzerland
Ergonomic Keyboard	6348	-A	United States	
		-B	United Kingdom	
		-C	French	
		-D	German	
		-E	Katakana (Japan)	
		-F	Reserved	
		-G	Spanish	
-H	Danish/Norwegian			
-I	Italian			
-J	Swiss/German			
-K	Swiss/French			
-L	Canadian English			
-M	Canadian French			
-N	Swedish/Finnish			

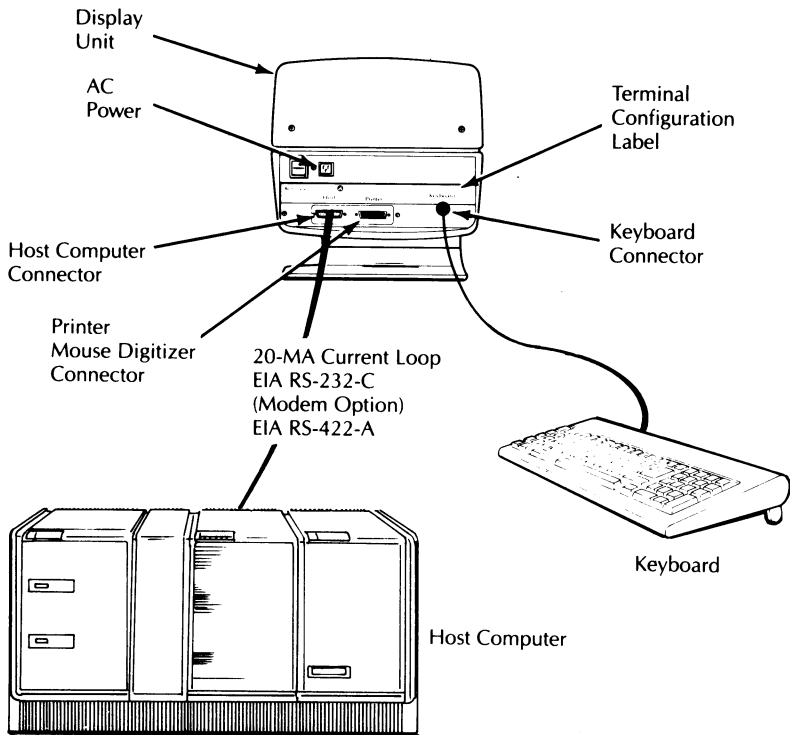

AA-0603

Figure 1-4. D411/D461 Terminal System Configuration

Display Unit

As shown in Figure 1-4, the display unit is the center of activity for the D411/D461 terminal. It houses the electronic hardware and firmware that provide the D411/D461 terminal with its sophisticated features.

The CRT mounted inside the display-unit housing is a 12-inch, green or amber phosphor, monochrome unit. The housing has external cable connections, and a power on/off switch at the rear. A display-screen brightness control is located on the lower-right front of the display unit. The housing sits on a base that lets you tilt the display for best viewing.

When power to the display unit is turned on, a self-test automatically verifies that the display unit and attached keyboard are in good working condition. The self-test examines the key elements inside the display unit: the read-only memory (ROM); read/write, or random-access memory (RAM); and both the host computer and printer/mouse/digitizer interfaces. The cable connection to the keyboard is checked along with the lamps and bell on the keyboard. If a failure is noted during the self-test, an error message is displayed across the top of the display screen identifying the failing element. For the D411 terminal, the self-test takes approximately 5.5 seconds to complete. For the D461 terminal, the DLL memory must be checked in addition to the terminal circuitry, so the self-test takes about 7.5 seconds.

Before you can operate the terminal, the display unit will read the nationality of the keyboard so that the nationality of the characters displayed will match that of the keyboard. The Terminal Configuration menu programs the baud rates and parity of the host computer and printer/mouse/digitizer interfaces. It also programs the mode of operation (Data General or ANSI, 7 or 8 bit). Finally, the display-unit features are initialized to emulate the Model D200 terminal (normal character spacing, single window of 24 rows with margins at columns 0 and 79, etc.).

Commands or display characters consisting of ASCII characters or character sequences control operation of the D411/D461 terminal. [The D411/D461 Programmer's Reference Manual](#) describes in detail how these commands can be used to manipulate all of the features described earlier in this chapter.

NOTE: *The D411/D461 terminal command set is an extension of the model D400/D450, which in turn is an extension of the model D200 terminal, so D200 as well as D400/D450 software is compatible with the D411/D461.*

Commands and display characters originate from one of two sources: the host computer when the terminal is on-line and the keyboard when the terminal is off-line. The system operation overview paragraph later in this chapter says more about on-line and offline operation.

Keyboard

The D411/D461 terminal supports 13 keyboard configurations (see Table 1-4). The keyboard connects to the rear of the display unit with a 1.2-meter (4-foot) cable.

Table 1-4. Keyboards Supported by the D411/D461 Terminal

U.S.	German
United Kingdom	Italian
Canadian/French	Katakana
Canadian/English	Spanish
Danish/Norwegian	Swedish/Finnish
French	Swiss/French
	Swiss/German

Each of the keyboard nationalities works with the display unit to develop ASCII character codes. The ASCII codes include a full set of 95 displayable characters, a delete code, control characters, and special user-function code sequences. In addition, when the terminal is off-line, the command header control code <036> can be produced.

NOTE: *In this manual, octal-based numbers are enclosed in angle brackets (<octal number>).*

The <036> code is used extensively in the Data General version of the D411/D461 command set. Appendix A of the programmer's reference manual lists all of the ASCII codes and code sequences and identifies the keys used to produce them.

As shown in Figure 1-5, the keys on the keyboard are organized functionally into the following groups:

- Main keypad
- Screen-management keypad
- Numeric keypad
- User-function keys
- Local-function keys

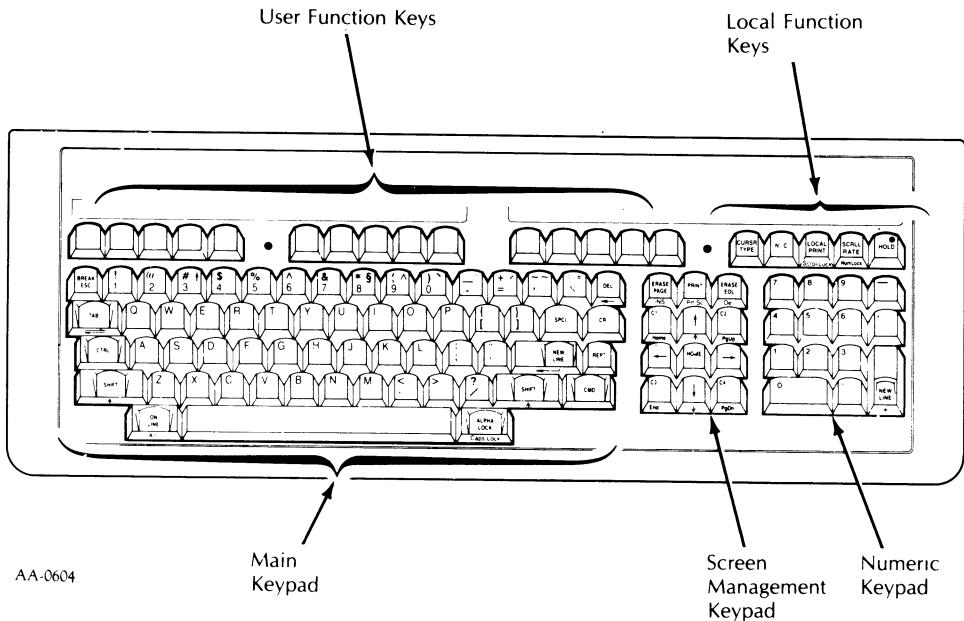

AA-0604

Figure 1-5. D411/D461 Terminal Keyboard Layout

The differences in the nationalities of keyboards can be seen in Appendix F of the programmer's reference manual. Chapter 3 of this manual provides a detailed description of the keypads.

The main keypad is similar to a standard typewriter keyboard, with a few additional functions. You can enter all the displayable ASCII characters from the main keypad. The 12-key screen-management keypad is used for cursor control, screen erase, and special user functions (keys C1 through C4). The 14-key numeric keypad duplicates some of the main keypad functions, but the keys are arranged in a calculator fashion to make entering numerical data easier. The user-function keys (F1 through F15) and the CTRL and SHIFT keys on the main keypad combine to produce most of the special code sequences. The code sequences are often used to invoke special user functions in the host software servicing the D411/D461 terminal. The local-function keys control several of the unique features of the terminal including

cursor appearance, character spacing, print operations, vertical scroll rate, and screen hold (stop/start character traffic from keyboard and host).

System Operation Overview

You can use the D411/D461 terminal in two basic operating states: on-line and off-line. On-line means the terminal is using a communication line to a host computer, as shown in Section A of Figure 1-6. Off-line means the communication line to the host computer is not used, as shown in Section B of Figure 1-6. The on-line state will prove more valuable in most environments because, in addition to the terminal itself, the host computer system and its resources are accessible. These resources often include development and application software plus hardcopy output devices such as printers and plotters. The off-line state is somewhat restricted because the terminal keyboard, display unit, and an optional printer comprise the complete system.

When you turn on the D411/D461 terminal, it automatically performs the self-test. As the self-test completes, but before you can begin operating the terminal, it checks to see if the appropriate host connector is plugged into the rear of the display unit. If it is, the ON LINE lamp on the keyboard goes on and the terminal enters the on-line state. If no host connection exists, the ON LINE lamp blinks. While the ON LINE lamp blinks, no characters can be entered from the keyboard. Pressing the ON LINE key while holding down the CMD key will place the terminal off-line and turn off the ON LINE lamp.

On-Line Operation

In the on-line state, data entered at the keyboard is first routed to the display unit and then transmitted to the host computer in the form of ASCII characters. The terminal does not process or display characters sent directly from the keyboard. The character format, the default state of operation and parity, and the baud rate used to communicate with the host computer are selected with the Terminal Configuration menu. Chapter 2 contains details for using the menu. If no match exists between the terminal and host-computer communication characteristics, a transmission-error character in the form of a block smaller than the cursor will appear on the display screen.

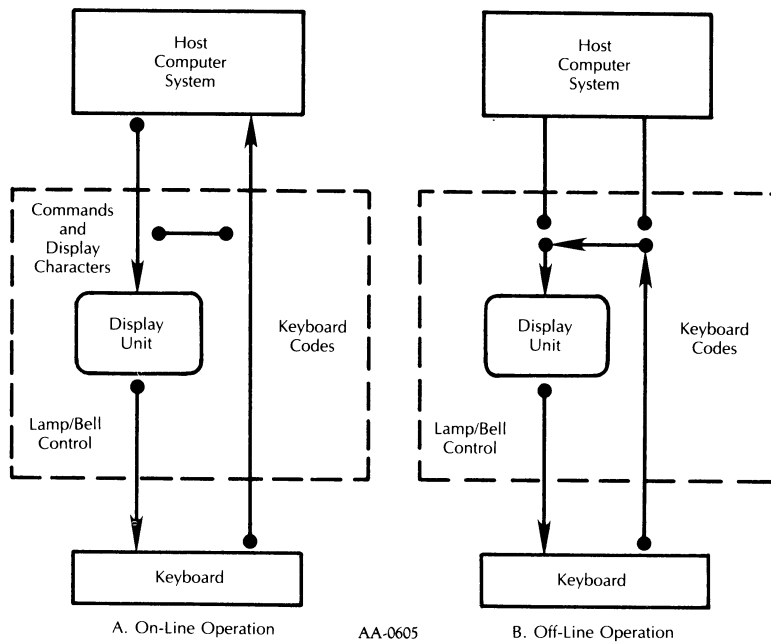

Figure 1-6. D411/D461 Terminal and Host Computer Operation

Five keys grouped in the upper-right corner of the keyboard perform the same function in both the on-line and off-line states. These are the local-function keys. Four of these keys send no code at all to the host computer; when they are pressed, the display unit performs the selected function. These four keys control the cursor type, character spacing (normal or compressed), local print operations, and the vertical scrolling rate. The fifth local function key is used to freeze the contents of the display screen. When the terminal is on-line, the HOLD key sends a CTRL-S (ASCII DC3 or <023>) and CTRL-Q (ASCII DC1 or <021>) to the host to stop and resume, respectively, the character flow from the host.

Downloading custom-character sets to the D461 terminal is a special type of on-line operation. Before the download can take place, the

custom-character definitions must be created and saved in a data file or program on the host computer system. Then, on user request, the character definitions can be transmitted to the terminal and saved in the DLL memory.

Off-Line Operation

As shown in Section B of Figure 1-6, in the off-line state no connection exists between the terminal and the host computer. If a communication link to the host does exist and the terminal is on-line, you can switch to off-line operation by pressing the ON LINE key while holding down the CMD key.

The terminal can perform all functions off-line, but you must enter all display characters and commands manually at the keyboard. With the terminal off-line, data entered at the keyboard is interpreted directly by the display unit.

Chapter 2

Installation and Maintenance

Introduction

This chapter covers all the steps required to install and check operation of the D411/D461 terminal. The information is organized as follows:

- Site requirements
- Repacking instructions
- Installation instructions
- Operational checkout instructions
- User maintenance

The installation and operational checkout instructions in this chapter also include steps for terminal configurations that involve a printer, a mouse, or a digitizer. Follow these instructions carefully.

Site Requirements

Your installation site for the D411/D461 should meet the space, environmental, power, and communication requirements defined in this manual. (See specifications inside front cover.) If possible, locate the terminal on a desk or table in a normal office environment with the temperature at or near 24°C (75°F) and the relative humidity at or near 50 percent. Be sure that all terminal cables and power cords reach their connection points, and that the ac power source matches the voltage and frequency requirements of the terminal (and optional printer, mouse, or digitizer). If you connect the terminal to a host computer over telephone lines, install a terminal-compatible modem, or a current loop or EIA cable from the host computer to the terminal site.

The selection of a communication line from the host computer to the terminal depends on the cable length required, whether a modem is to be used, and the configuration of the host system.

The D411/D461 terminal permits use of an EIA RS-232-C as well as a 20-mA current loop and an EIA RS-422-A line.

The current-loop line and EIA RS-422 line are intended for relatively long cable lengths when a direct connection between the host and terminal is made. The 20-mA current loop supports transmission rates to 9,600 baud; EIA RS-422-A cabling supports rates to 19,200 baud. When a short [15 meters (50 feet) or less] direct connection is required, or the terminal is to interface with a Bell 103, 113, or 212A compatible modem, the EIA RS-232-C communication line should be used. Detailed cabling information is provided in the D411/D461 installation data sheets.

NOTE: *Maximum lengths with cables are 50 feet for RS-232-C, 4,920 feet for RS-422-A, and 1,200 feet for current loop at 2,400 baud.*

NOTE: *If the D411/D461 terminal is to be connected to the host over the telephone lines with a Bell 103, 113, or 212A compatible modem, make sure the modem installation is scheduled early enough that the terminal installation is not delayed.*

Repacking

The D411/D461 terminal display unit and keyboard are packed as shown on the installation data sheets. Save the packing material in case reshipment is necessary. Should the original packing material be discarded, however, use the installation data sheets as a guide in repacking the terminal for shipping.

Installation

After you have selected an installation site, and have unpacked the terminal and accounted for all parts, you can begin the installation. Perform the following steps:

1. Move the terminal equipment to its intended work surface and place the terminal so the rear is accessible.
2. Find the terminal configuration label on the rear of the display unit as shown on the installation data sheets. Verify that the model number for the unpacked unit, located on the lower left of the label, matches the number ordered. In particular, verify that the power configuration of the unpacked unit matches the ac power source. The display unit model numbers are explained in Chapter 1, Table 1-3.

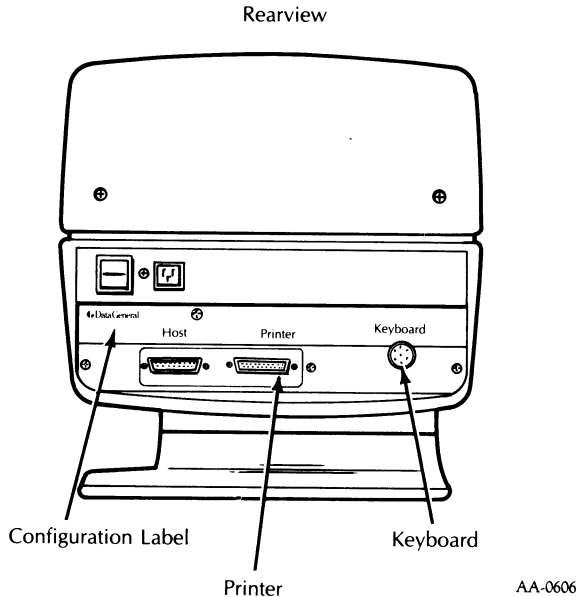
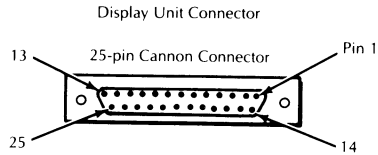
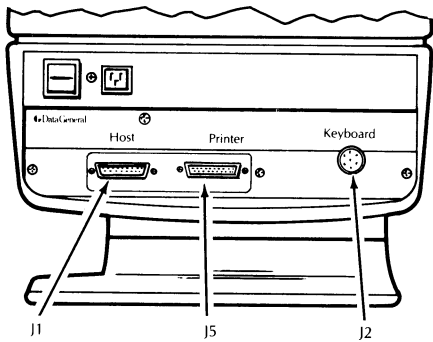

Figure 2-1. Rear View of D411/D461

3. Connect the keyboard cable to the keyboard connector at the rear of the display unit.

CAUTION: *Do not disconnect the keyboard cable from the display unit when the display unit is powered up. If you do, terminal operation may become erratic and unpredictable.*

NOTE: *The guidelines for selecting host-to-terminal interface cabling were provided in the Site Requirements paragraph of this chapter. The next step assumes you have the correct cabling as determined by the host computer and the selected communication system.*



Passive Current Loop

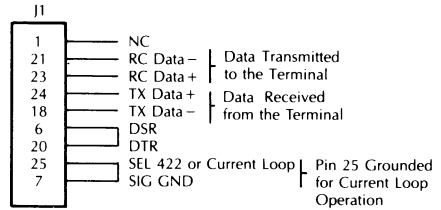

Keyboard

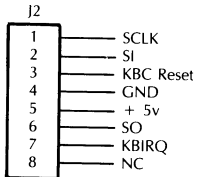

EIA RS-422A

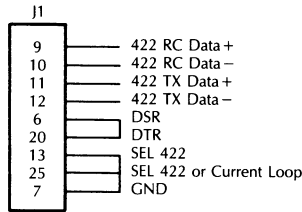

Slave Printer

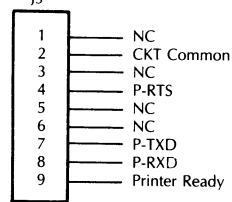

EIA Controllers

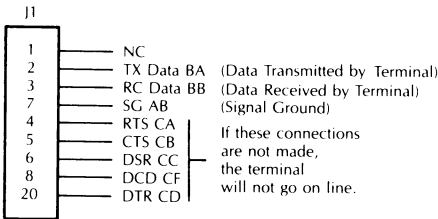

Slave Printer

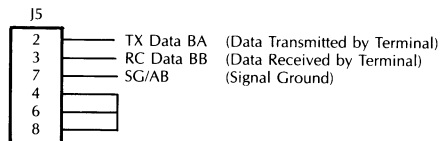

Modem

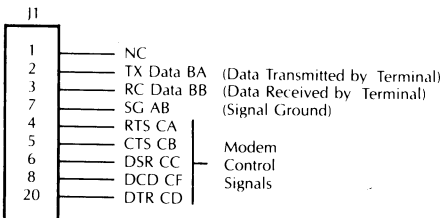

Mouse or Digitizer

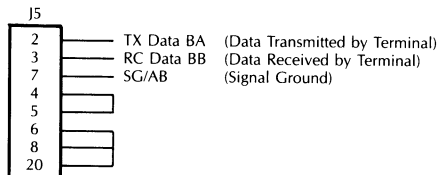

AA-0635

Figure 2-2. Rear View and Connectors of the D411 and D461

4. Connect the communication cabling between the host or modem and the rear of the display unit. Secure the display-unit connection with the two screws provided with the 25-pin Cannon connector that plugs into the rear of the display unit.

NOTE: *The installation data sheets provide detailed cabling information for the D411/D461 terminals. In addition, Figure 2-3 shows the terminal interface for the standard EIA RS-232-C cables, modem cables, and printer/mouse/digitizer-port cables. When not using a Data General EIA cable for an EIA connection, wire the terminal end of the 25-pin connector as shown in Figure 2-4. Note that Data General cables are all shielded and that shielded cables must be used to comply with FCC, Part 15. Figure 2-5 shows how shielded cables must be terminated. Figure 2-6 shows the 20-mA current-loop cables from Data General. Data General 20-mA current-loop cables are all wired for a passive connection in which the host system supplies the power to drive the terminal interface. When a Data General current-loop cable is not used for a 20-mA current-loop connection, wire the 25-pin Cannon connector for a passive connection. For 20-mA current-loop cabling, a two-twisted-pair, low-capacitance shielded cable is required. Contact Data General Field Engineering for approved cable vendors.*

EIA RS-232-C

Host/Controller	Cables Required Model + (Assembly)	Cable Model & Length Suffixes
Convenience Panel Systems With 25-Pin Connectors	1340 (005-13258)	Model 1340 cable (EIA RS-232C) is 25' long. Model 1340-A is 60' long. 1340-A may be used in place of model 1340. Models 1241, 1243, 1244, and are adaptor cables. Each is 18' long.
ALM-8 Systems With Backpanel Connection	1340 (005-13258) And 1241 (005-13270)	
ULM, microNOVA, 422X, or microNOVA Console Interface	1340 (005-13258) And 1243 (005-13271)	
ALM-16 With Backpanel Connection	1340 (005-13258) And 1244 (005-13273)	
Primary Console Interface With Backpanel Connection	1340 (005-13258) And 1257 (005-13389)	
Modem	1338 (005-13266)	

Note: Maximum allowable cable length for RS-232-C is 50 ft.

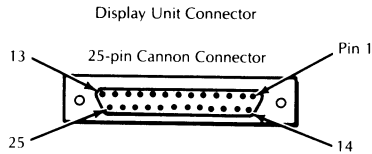

Modem Cable Model 1338 005-13266

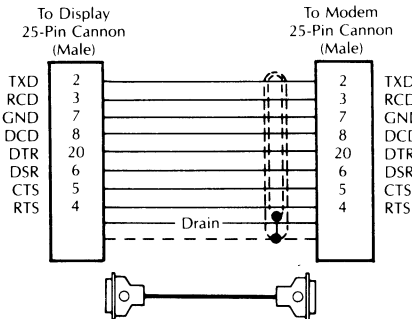

Standard EIA RS-232-C Cable Model 1340 005-13258

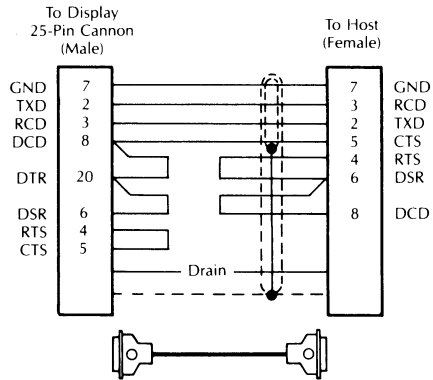

AA-0607

RS -232-C Host-End Adapter Cables

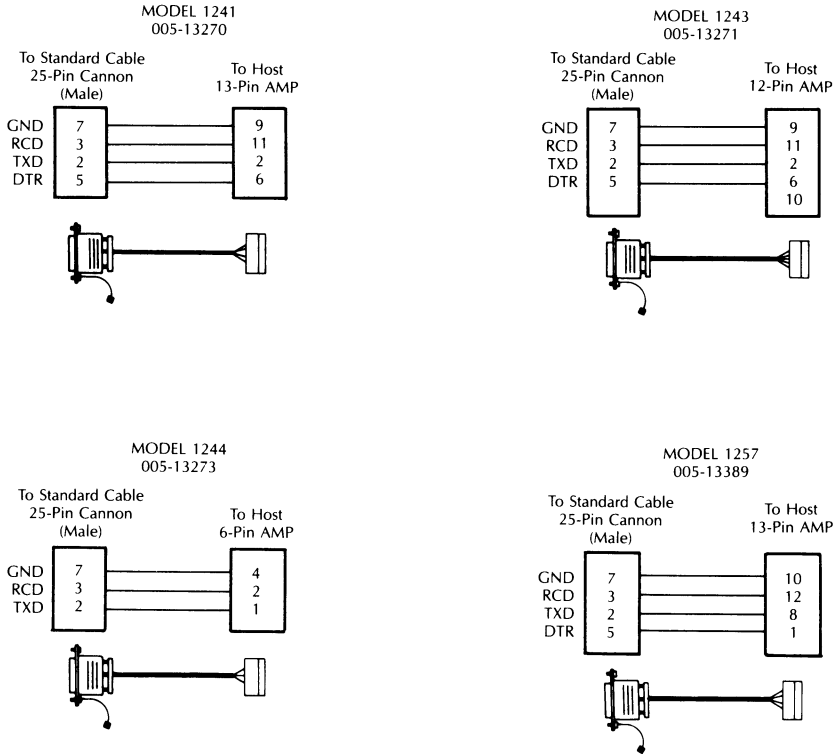

AA-0608

Figure 2-3. Data General EIA RS-232-C Terminal Interface

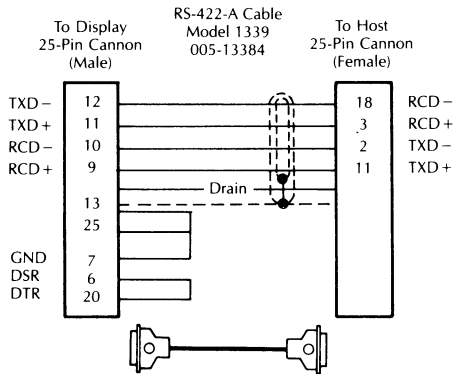

EIA RS-422-A

(D215 ONLY)

Host/Controller	Cables Required Model & (Assembly)	Cable Model & Length Suffixes
	1339 (005-13384)	Model 1339 Cable (EIA-422-A) is 25' Long Extension Cables (EIA-RS-422-A) 1339-A (005-20905) Is 50' Long 1339-B (005-20906) Is 100' Long 1339-C (005-20907) Is 300' Long 1339-D (005-20908) Is 500' Long

AA-0609

Note: Maximum allowable cable length for RS-422-A is 1500 m (4920 feet).

Figure 2-4. RS-422-A Host/Controller Cable

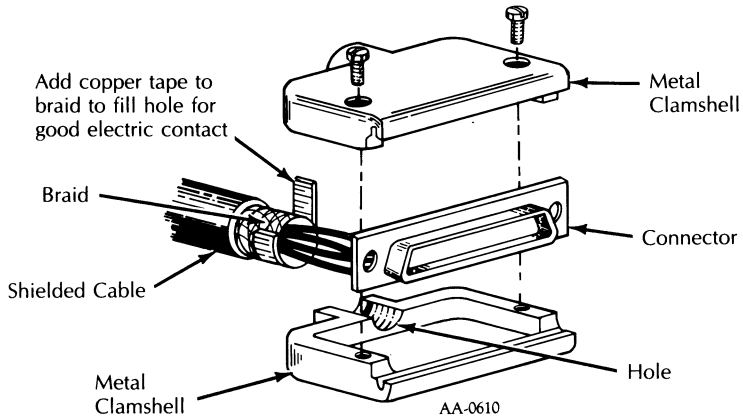

Figure 2-5. Termination Details for Non-DG Shielded Cables

NOTE: *For more information on cable-termination details and parts availability, contact Data General Field Engineering.*

20-mA Current Loop (D211 Only)

Host/Controller	Cables Required	Cable Model & Length Suffixes
Convenience Panel Systems With 25-Pin Connectors	1341 (005-13260)	Model 1341 cable (20mA Current Loop) is 25' long. Models 1242 And 1245 are adaptor cables. Each is 18' long
ULM, microNOVA 422X, or any Single Line Console Interface With Backpanel Connection	1341 (005-13260) and 1242 (005-13272)	Current Loop Extension Cables Model 1341-A is 50' Long Model 1341-B is 100' Long Model 1341-C is 300' Long Model 1341-D is 500' Long
ALM-16 With Backpanel Connection	1341 (005-13260) and 1245 (005-13274)	

Note: See Installation Data Sheet, part number 010-000660, for Maximum Current Loop Lengths and baud rates.

Extension cable or cables may be used in addition to model 1341 for longer distances, subject to length limitations shown in 'maximum cable lengths' table. Models 1341-A, -B, -C, -D, may not be used without model 1341.

Current Loop Host-End Adapter Cables

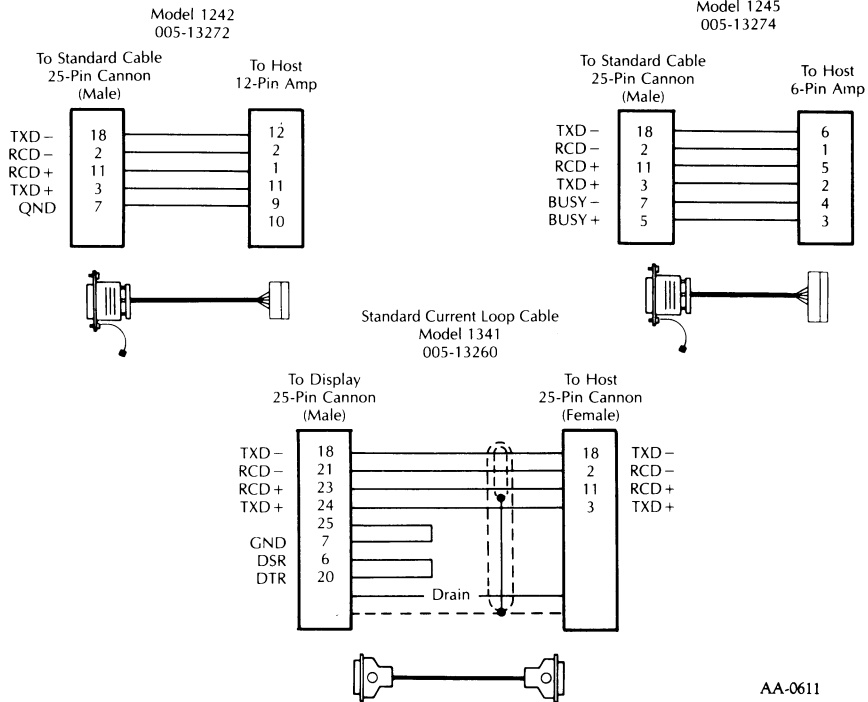

AA-0611

Figure 2-6. Data General 20-mA Current Loop Terminal Interface

5. The D411/D461 terminal supports Data General monochrome graphics slave printers as output devices. The D461 supports optical mice and digitizers as input devices to control the graphics cursor. These devices attach to the printer/mouse/digitizer connection. Install them as follows:
 - a. Verify that the ac power source matches the requirements of the device.
 - b. Connect the device to the printer/mouse/digitizer connector at the rear of the terminal. Figure 2-2 shows the connectors on the terminal.
 - c. Follow instructions in the printer, mouse, or digitizer manual to further prepare these devices for operation.
 - d. Set communication options such as baud rate with the Terminal Configuration menu according to Step 7 of these installation instructions.

WARNING: *The terminal comes equipped with a three-conductor ac power cord. The power cord must be plugged into a grounded three-contact electrical outlet.*

6. Make sure the terminal display power-control switch on the rear of the display unit is set to the power-off position. Plug the display unit power cord into the ac power source. Position the terminal equipment for normal operation.
7. Set the terminal communication options such as mode, baud rate, parity, and data bits using the terminal configuration menu. After you power up, to call up the menu on the display screen, simultaneously press the CMD and N/C keys. Table 2-1 lists all the terminal communication options and their respective default settings (those settings set by the manufacturer). These are the settings your terminal will come set with.

Table 2-1. D411/D461 Default Terminal Configurations Settings

Parameters	Default Settings
HOST	
Baud Rate	9,600
Parity	None
Data Bits	8 Bit
PRINTER	
Baud Rate	9,600
Parity	None
Data Bits	8 Bit
ANSI/DG MODE	DG
50/60 Hz	60 Hz
AUTO SCREEN DIM	15
SCROLL RATE	Jump
CURSOR TYPE	Reverse-video block

To use the menu, simultaneously press the CMD and N/C keys. The menu looks like the one in Figure 2-7. The Terminal Configuration Menu is displayed in the language dictated by the keyboard nationality. To display the menu in English and override the native language, if other than English, press SHIFT-CMD-N/C.

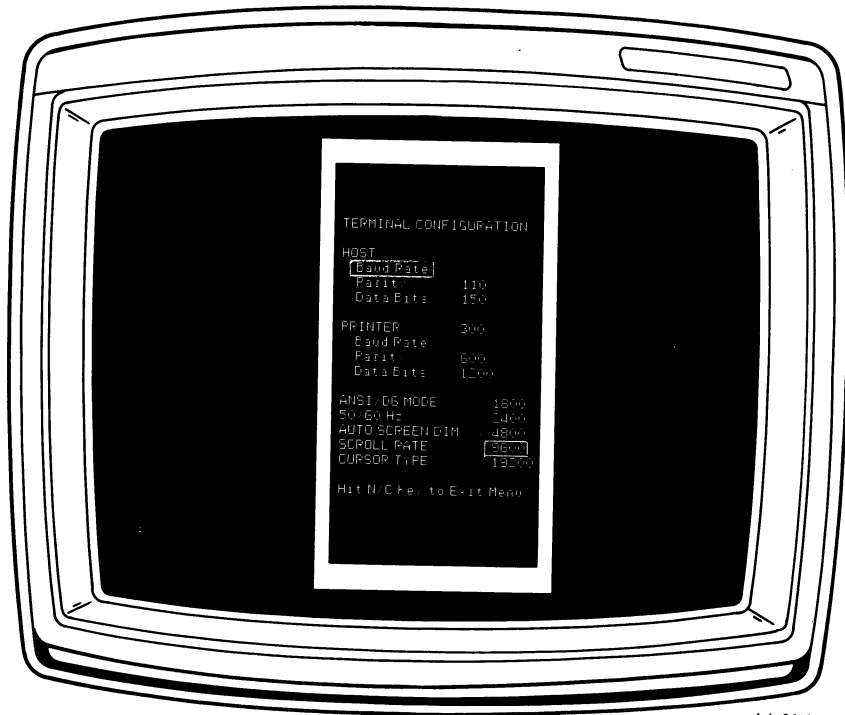

AA-0612

Figure 2-7. Menu for Terminal Communication Option Settings

Notice that the left column of the menu contains a list of the different terminal communication options. When the menu first comes up, notice that the cursor is over the option “HOST Baud Rate.” When the cursor appears over an option in the left column, the right column contains a list of the possible values you can select for that communication option. For example, when the cursor is over the option “ANSI/DG MODE,” the right column lists the possible values you can select for mode, namely, ANSI or DG Mode.

WARNING: *The tables displayed when you press the CMD and N/C keys determine the default configuration for the display terminal. Changing any values indiscriminately can adversely affect the operation of your terminal or printer. If you reset these screens intentionally, keep a record of the new values to protect against accidental resetting of baud rate, data bits, or parity. Otherwise, use the tables shown here to reset any values accidentally changed.*

To change the mode, use the Cursor Right (➡) key to move the cursor into the right column. Once the cursor is in the right column, use the Cursor Up (⬆) and the Cursor Down (⬇) keys to move the cursor up and down the list of possible settings. Select a value by placing the cursor over a value. Once you have made your selection, return to the list of terminal communication options by using the Cursor Left (⬅) key to move the cursor back to the left column. The cursor will move back to the HOST Baud Rate selection in the left column.

In order to select a value for another communication option, use the cursor-positioning keys to move the cursor up and down the list of options in the left column. For example, to set the host data bits, move the cursor down the list to the words “Data Bits” under the “Host” entry. When the cursor is over the words “Data Bits,” the selections “7 Bit” and “8 Bit” appear in the right column. To make a selection, use the cursor-positioning keys to move into the right column and then up and down the list of values.

You can leave the Terminal Configuration Menu at any time by pressing the N/C key. In order to enable the values which you’ve selected in the Terminal Configuration Menu, follow the steps outlined in the following table.

Table 2-2. Enabling Terminal Configuration Menu Settings

Communication Options	Enabling Procedure
Host Baud Rate	Go off-line (press the ON LINE key while pressing the CMD key) and then back on-line again.
Host Data Bits	Go off-line (press the ON LINE key while pressing the CMD key) and then back on-line again.
Host Parity	Go off-line (press the ON LINE key while pressing the CMD key) and then back on-line again.
Printer Baud Rate	Initiate print operation (see Chapter 3).
Printer Data Bits	Initiate print operation (see Chapter 3).
Printer Parity	Initiate print operation (see Chapter 3).
ANSI/DG Mode	Go off-line (press the ON LINE key while pressing the CMD key) and then back on-line again.
50/60 Hz	Power terminal down and then back up.
Auto Screen Dim	Exit terminal configuration menu.
Scroll Rate	Power terminal down and then back up, or reset terminal (press the CMD and ERASE PAGE keys simultaneously).
Cursor Type	Power terminal down and then back up, or reset terminal (press the CMD and ERASE PAGE keys simultaneously).

Using the Terminal Configuration Menu, set the following communication options:

- a. Set the HOST baud rate to match the baud rate selections at the host computer.
- b. Set the HOST parity to match the parity selections of the host computer.
- c. Set the HOST terminal operating mode to either “Data General” or “ANSI” mode of operation.
- d. Verify that frequency of the terminal is set to match the frequency of the power source and the terminal model number. If the frequency is set incorrectly, the screen image may flicker.
- e. Select either 7- or 8-bit host data operations for the terminal.
- f. Now select either 7- or 8-bit data operations for the printer. For 7-bit printer operations, set the terminal to 7-bit and even parity. For 8-bit printer operations, set the terminal to 8-bit and no parity.
- g. If you are using a printer with the terminal, select the printer baud rate. Set the baud rate on the printer to match the terminal printer-port parity and stop bits.
- h. Select timing for Auto Screen Dim. Select the time it takes the screen to blank after the last key is depressed. Once the screen is blank, press any key to return the display.

The D411/D461 terminal hardware is now installed and ready for checkout.

Operational Checkout

Before beginning normal use of the D411/D461 terminal, perform the checkout procedures in this section. If any of these checks produce results other than those indicated, go on to the User Maintenance section and consult Table 2-4 on Terminal Problem Diagnosis.

Self-Test and Off-Line Checkout

Self-test and off-line checks verify that the terminal and keyboard work properly when separate from a host computer:

1. Make sure the terminal is installed correctly.
2. Turn on power to the terminal with the on/off switch on the back.

The terminal will conduct a self-test of its components. If all parts are working you will receive the message "D411/D461 Self-Test OK" on your screen. If a problem is detected, the display will give you a number corresponding to the tests that failed.

Even though you get a successful self-test, you may want to give your terminal a more thorough checkout.

3. If the ON LINE lamp on the keyboard is on steady or blinking, press and hold down the CMD key while pressing the ON LINE key (CMD-ON LINE). The ON LINE lamp should turn off, indicating the terminal is off-line. If the keyboard does not operate, check to make sure it is plugged in correctly.
4. Set the command syntax mode to Data General 8 bit using the Terminal Configuration menu. Then perform the terminal off-line checkout and demonstration procedure in Table 2-3.

Table 2-3. Terminal Off-line Checkout And Demonstration Procedure

Procedure	Expected Results
Check ON LINE lamp.	The ON LINE lamp is on.
Press and hold CMD key while pressing ON LINE key.	The ON LINE lamp turns off.
Press ALPHA LOCK key.	The ALPHA LOCK lamp goes on.
Enter some text from the keyboard.	The text entered appears in uppercase.
Press ALPHA LOCK key.	ALPHA LOCK lamp goes off.
Enter more text.	The text appears in lowercase (unless SHIFT key is pressed).

Table 2-3. Terminal Off-line Checkout And Demonstration Procedure (continued)

Procedure	Expected Results
Press the CR key.	The cursor returns to the left margin of the same line.
Press the SPCL key; then press the A key followed by the \ key.	The Data General International character A appears.
Press CTRL and G simultaneously (CTRL-G).	The terminal bell emits a beep.
Press CTRL-T and enter some text.	The text appears underscored.
Press CTRL-\ and enter some text.	The text appears dimmed and underscored.
Press CTRL-C and CTRL-N and enter some text.	The text blinks, is dimmed, and is underscored.
Press CTRL-U and enter some text.	The underscore does not appear under the new text but remains under the old text.
Press CTRL-] and enter some text.	The new text is brightly displayed, but the old text remains dim.
Press CTRL-O and enter some text.	The new text does not blink, but the old text continues blinking.
Press CTRL-D.	All text stops blinking.
Press each of four cursor-control keys marked with arrows.	The cursor moves in the direction of the arrows on the keycaps.
Press HOME.	The cursor moves to the upper-left corner of the screen.
Press CURSR TYPE four times and note the appearance of the cursor after each key depression.	The cursor changes appearance with key depressions as follows: blinking, underline, cursor off, blinking reverse-video block, and reverse- video block.
Press CTRL-S, enter some text, and repeatedly press NEW LINE until the cursor moves past the bottom of the screen.	The cursor moves to the bottom of the screen and then jumps to the top and continues moving downward; text is not affected.
Press CTRL-R and repeatedly press NEW LINE until the cursor moves past the bottom of the screen.	The cursor moves to the bottom of the screen; then text moves up one line with each depression of NEW LINE.
Press CTRL-T, CTRL-\, CTRL-C, CTRL-N, CTRL-V and enter some text.	Text is underscored, dimmed, blinking (CTRL-C turns blinking on, CTRL-N enables blinking), and reverse video.

Table 2-3. Terminal Off-line Checkout And Demonstration Procedure (continued)

Procedure	Expected Results
Press CTRL-L and enter some text.	The screen clears, and the new text is not underscored, dimmed, blinking, or reverse video.
Move the cursor to the middle of the previously entered line of text and press ERASE EOL.	Characters from the cursor position to the end of the line are erased.
Enter a string of text, and press the N/C (NORM/COMP) key several times.	The text appearance alternates between compressed format and normal format with each key depression.
Press the HOLD key, and enter some text.	The HOLD lamp turns on, but text entered is not displayed.
Press the HOLD key again.	The text entered in the previous step is displayed, and the HOLD lamp goes off.
Enter some text in the lower part of the screen, and repeatedly press NEW LINE until the cursor moves past the bottom of the screen.	The cursor moves to the bottom of the screen; then text moves up in jumpy, one-line increments with each depression of NEW LINE.
Enter some text and press and hold down NEW LINE and REPT.	The text moves quickly up and off the screen and in a jumpy fashion (if NEW LINE and REPT are held down long enough).
Press SCROLL RATE, enter some text, and press and hold down NEW LINE and REPT.	The text scrolls slowly and smoothly up and off the screen (if NEW LINE and REPT are held down long enough).
Press SCROLL RATE, enter some text, and press and hold down NEW LINE and REPT.	The text scrolls smoothly up and off the screen but faster than in the previous step.
<p>NOTE: <i>In the rest of the checkout, command sequences such as <036>FV must be entered from the keyboard. In all cases, <036> is entered by typing CMD-BREAK ESC. The characters following the <036> must be entered exactly as shown (with no embedded spaces). Be sure to press the SHIFT key for uppercase functions.</i></p>	
Enter <036>D and some text.	The text appears in reverse-video form.
Enter <036>E and some text.	The text appears normal without reverse video.

Table 2-3. Terminal Off-line Checkout And Demonstration Procedure (continued)

Procedure	Expected Results
Enter a string of text; enter <036>FV and <036>FL followed by a second string of text; enter <036>FM	Both text strings appear normal; the first string is unprotected; the second string is protected.
Position the cursor to the beginning of the first string entered in the previous step; then enter <036>FF	The first string of text is erased; the second string remains displayed.
Press ERASE PAGE.	Protected text is erased, and the cursor moves to the upper-left corner of the screen.
Enter a full line or more of text followed by <036>FX28<?	The text shifts to the left 40 columns with the cursor in the left column of the screen; the text margins are set to columns 40 and 207.
Enter <036>FD28 Press NEW LINE.	The text shifts to the right 40 columns. The cursor moves to the next line at the new margin (column 40).
Enter a string of text that extends past the rightmost column of the screen.	The text scrolls to the left one column for each character entered at the rightmost column.
Enter <036>F] followed by more text. Enter <036>F^	The cursor disappears off the right side of the screen. The text shifts to the left, displaying the cursor and all text entered in the previous step.
Enter <036>FX3050 Press ERASE PAGE key.	The cursor moves to the new left margin (margins are set to columns 48 and 80). The screen is cleared, and the cursor moves to the left margin and top line.
Enter text in top and bottom halves of screen. Enter <036>FB0<00<1	The cursor moves to the upper-left corner of the screen, and the screen is split into two windows. In the top window, text appears compressed with left margin in column 0 of screen. In the bottom window, text is compressed with left margin shifted right of column 0.

Table 2-3. Terminal Off-line Checkout And Demonstration Procedure (continued)

Procedure	Expected Results
Repeatedly press NEW LINE.	The cursor moves to the bottom of the top window. Then the text in the window scrolls up one line with each depression of NEW LINE.
Enter <036>FP300<	The cursor moves to the top row (row 12) and left margin on the bottom window.
Enter some text in the bottom window followed by <036>I	The text in the bottom window scrolls down one line.
Position the cursor at the middle of a line of text in the bottom window. Enter <036>J	A blank space is inserted in the text at the cursor position.
Enter <036>FH	A blank row is inserted at the row containing the cursor.
Enter <036>FI	The blank row from the previous step is deleted.
Enter <036>K	The character at the cursor position is deleted.
Enter <036>FA	The terminal bell sounds, the screen is cleared, and the cursor moves to the upper-left corner of the screen.
Enter <036>N and then type on the keyboard.	Data General International characters are displayed.
Press CMD-ERASE PAGE.	The screen clears, the terminal performs a self-test, a bell tone sounds, and the cursor appears in the upper-left corner of the screen (terminal reset). "D411/D461 Self-Test O.K." appears. The ON LINE lamp goes on if the terminal is connected to a host, or blinks if the host connection is not complete.
<p>NOTE: <i>The off-line check for the D411 terminal is now complete. The remaining steps check the DLL memory and the graphics cursor, and apply to the D461 terminal only.</i></p>	
Press CMD-ON LINE.	The ON LINE lamp goes off.
Enter <036>FeO:	There are no visible results: all DLL character sets have been reserved for graphics.
Enter <036>Fd	The Screen displays "9JL", indicating 940 characters have been reserved for graphics. If "9@@@" is displayed, enter <036>FeO: again, and retry this step.

Table 2-3. Terminal Off-line Checkout And Demonstration Procedure (continued)

Procedure	Expected Results
Enter <036>L@@@@@X_@Q_ followed by CTRL-SHIFT-2	The cursor disappears, a line is drawn from the lower-left corner of the screen to the upper-right corner, and the cursor reappears.
Enter <036>Fd	The screen displays "9ZJ", indicating 842 characters are still available for graphics.
Press CMD-ERASE PAGE.	The screen clears, the terminal performs a self-test, a bell tone sounds, and the cursor appears in the upper-left corner of the screen followed by the words "D411/D461 Self-Test OK (terminal reset)." The ON LINE lamp goes on if the terminal is connected to a host, or blinks if the host connection is not complete.
NOTE: <i>The following steps check the graphics cursor for the D461 terminal.</i>	
Enter <036> GB	The graphics cursor is turned on and appears in the lower-left corner of the screen with left and bottom portions of the cursor cut off by screen boundaries.
NOTE: <i>The graphics cursor must be turned on for the following commands to operate. Enter <036> GB to turn the cursor on.</i>	
Enter <036> GH2 Press each of the cursor control keys (the arrow keys on your screen-management keypad).	Cursor tracking by the keyboard is enabled. The graphics cursor moves in the direction of the arrow pressed. If a cursor-control key is pressed for more than one second, or if two cursor-control keys are pressed simultaneously, the cursor moves steadily across the screen.
Press CMD-CURSR TYPE.	The x-y coordinates of the graphics cursor appear on the screen at the location of the alphanumeric cursor when the command is given.
To check cursor tracking of an installed optional mouse or digitizer, enter <036> GH4 from the keyboard.	Cursor tracking for the device is enabled. You should be able to move the graphics cursor as shown in the user manual for the device being used.
Enter <036> GC	Cursor disappears from the screen.

On-Line Checkout

Following a successful self-test and off-line checkout, test communication with the host computer.

NOTE: *Before proceeding, make sure the host computer system is operational and equipped with the software needed to communicate with the terminal.*

Proceed to test communication with the host:

1. If the terminal is off-line (ON LINE lamp on keyboard is off), press CMD-ON LINE. The ON LINE lamp should come on, indicating that the terminal is on-line with the host.
2. Log on to the host-resident software to verify that the host/terminal communication link is working.

Off-Line Printer Checkout

This check verifies that the printer connected to the rear of the D411/D461 terminal produces hard copy as directed from the keyboard.

Before proceeding, make sure the printer is installed correctly. Be sure the available power source is in accord with the printer model number. Then, using the Terminal Configuration menu, set the terminal to 7-bit and even parity; configure the printer to receive characters with 7 data bits, even parity, and 1 stop bit; and set the printer baud rate to match the terminal printer/mouse/digitizer-port baud rate.

The printer interface cable should be connected between the printer and the printer/mouse/digitizer connector at the rear of the display unit. The printer power cord should be plugged in, and the printer should be on-line, loaded with paper, and ready to print.

Proceed with the checkout steps:

1. With the terminal off-line, use the keyboard to enter both full-intensity and dim characters on the display. To begin a string of dim characters, first enter CTRL-\`\;` to end a string of dim characters, enter CTRL-]`]`.
2. Move the cursor to the window “home” location and press the LOCAL PRINT key to access the Print Menu. Select Print Window. All characters between the margins in the current window should print. For the printer to print all characters

between the D411/D461 margins, the printer line length must be equal to or greater than the number of character columns between the margins.

3. With the cursor at “home,” press LOCAL PRINT to access the Print Menu. Select Print Form. Only the full-intensity characters in the window should print.

If a Data General dot-matrix graphics printer is connected, perform a bit image dump:

1. Enter some text, enter CTRL-T, and then enter more text, which will appear underscored. Now enter CTRL-U and CTRL-N followed by more text, which will be blinking but not underscored.
2. Press CR.
3. Press the LOCAL PRINT key to access the Print Menu. Select Form Bit Dump. All characters within the margins of the active window, regardless of whether they have blink or underscore attributes, should print. The blinking text is printed as regular text, and underscored text is printed with underscore.

User Maintenance

User maintenance can be divided into two categories: preventive maintenance and problem diagnosis.

Preventive maintenance for the D411/D461 terminal primarily involves maintaining a clean, dust-free environment that conforms to the specifications listed inside the front cover of this manual. If dust accumulates on the terminal, wipe it with a clean, dry, dust-free cloth. Be careful not to obstruct the cooling vents on top of the terminal.

If a problem appears to develop with the terminal, you can take a few steps to solve it. See Table 2-4 for a list of failure symptoms and the corresponding solutions. If the suggested solution does not fix the failure, or if an obviously serious problem occurs, contact Data General Field Engineering for help.

Table 2-4. Terminal Problem Diagnosis

Failure Symptom	Solution
Nothing happens when terminal is turned on.	Check the terminal power-cord connection and verify that the ac power source to the cord is turned on.
The bell does not ring or keyboard lamps do not light when the terminal is turned on.	Verify that the keyboard cable connection at the rear of the display unit is secure and that the keyboard cable is attached to the proper connector.
The cursor is not displayed on the screen within 10 to 15 seconds after power to the terminal is turned on.	Adjust brightness control on the display unit to verify screen brightness is not turned down too far for viewing.
Error message (32K ROM Checksum, Screen RAM, DRCB RAM, Keyboard not present, NVRAM Checksum, Row Buffer RAM, Host UART, Printer UART) is displayed when the terminal is turned on.	Contact Data General Field Engineering for help. Try using the terminal even though the error message appears; the failure may not be fatal to normal terminal operation.
The terminal will not go on-line (ON LINE lamp blinking or off).	Verify that the cable connection from the host computer to the terminal is secure; if a user-supplied cable is installed, verify that the terminal end of the cable is wired as shown in Figure 2-5.
Data entered at the keyboard is not displayed either on-line or off-line.	Is the HOLD lamp on? If so, press the HOLD key to unfreeze the screen. If not, try pressing CTRL-Q. Is the cursor visible on the screen? If not, data entered may be located outside of the display area.
Data entered at the keyboard is not displayed (on-line only).	Verify that the host computer system is operating.
UART error character is displayed (.).	Verify that the baud rate and parity settings of the Terminal Configuration menu are set as intended. If settings must be reselected, go off-line and then back on-line to reprogram UART with new settings.
Data entered at the keyboard is not the same as the data displayed.	Verify that the baud rate and parity settings are set as intended. If they are, press CMD-ERASE PAGE to reset the terminal and ensure that the display character set matches the keyboard nationality.
The screen image flickers.	Verify that the 50/60-Hz parameter of the Terminal Configuration menu is set to match the frequency of the power source.
The printer, mouse, or digitizer does not work with the terminal.	Verify that the device is installed and set up to operate with the terminal as described in this chapter.

Chapter 3 Operation

Introduction

This chapter contains the following operation information about the D411/D461 terminal:

- Display unit controls and indicators
- Power-up and power-down procedures
- Operating procedures
- Keyboard controls and indicators
- Mouse and digitizer operation (D461 terminal only)
- Generalized downloading procedures for user-defined character sets (D461 terminal only)

The terminal operating procedures in this chapter are limited in scope because the software in the host computer controls most on-line operation details. Chapter 1 helps clarify this point and includes a discussion of terminal on-line and off-line operation. Off-line operating procedures receive most of the attention in this chapter because they depend only on the characteristics of the D411/D461 terminal.

If you have a printer configured with your D411/D461 terminal, see the printer manual for printer-operating instructions.

Display Unit Controls and Indicators

The display unit has one control on the front, a display screen, and connectors at the rear.

NOTE: *Except where specified, the operation characteristics of the terminal described in this chapter apply to both the Data General and ANSI modes of operation.*

The power ON/OFF switch is located on the rear of the display unit.

A control on the lower-right front of the display unit (Figure 3-1) changes display-screen brightness. Slide the control to the right to increase brightness, to the left to decrease brightness.

The terminal bell rings once when the terminal is first turned on and a second time when the automatic self-test is complete. The bell is programmable and can be sounded off-line from the keyboard (press CTRL-G) or on-line by the host computer.

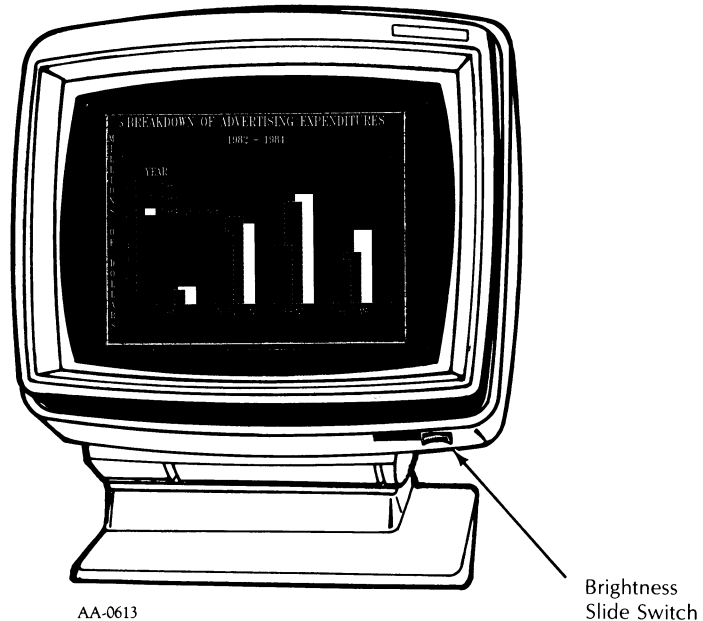

Figure 3-1. Display-Unit Brightness Control

Terminal Power-Up/Power-Down Procedures

The power on/off control is on the left rear of the display unit.

Power-Up Procedure

Before applying power, verify that the terminal has been installed in accordance with the procedures in Chapter 2. The power-application steps in the following procedure will work whether or not a host computer is connected to the terminal:

1. Apply power to the terminal by setting the power control to the “on,” or “1,” position.
2. When first turned on, the terminal executes its self-test.

NOTE: *When the terminal is not connected to a host computer, keyboard input is disregarded, and the ON LINE lamp blinks until you press and hold down CMD while pressing ON LINE (CMD-ON LINE). Then the ON LINE lamp turns off to indicate the terminal is off-line.*

3. To operate the terminal on-line, log on the host computer in accordance with the host software requirements. The details of this step should be found in the host system software documentation.

The descriptions of keyboard controls and indicators in this chapter summarize off-line operation of the terminal. On-line operation is determined by the host software interacting with the terminal functions.

Power-Down Procedure

During normal use, the terminal should be turned off only when it is not expected to be used for several hours. When power is turned off on a D461 terminal containing downloaded user-defined character sets, the character sets are lost. The download procedure must be repeated each time power is turned back on if the user-defined character sets are needed.

If the terminal is not connected to a host computer system, turn off power by setting the power control on the rear of the display unit to “off.”

If the terminal is connected to a host computer system, first log off the host software before shutting off the power. To log off the host software, the terminal must be on-line (ON LINE lamp on). Use the CMD-ON LINE key sequence to switch the terminal between the on-line and off-line modes.

Terminal Operating Procedures

The operating characteristics of the D411/D461 terminal depend on whether the terminal is being used off-line or on-line with a host computer.

On-line operation is controlled by the host. Read host system and application documentation for detailed operating instructions pertaining to the host-resident software. Off-line operation receives more attention in this user’s manual because, off-line, you can exercise the same terminal features (and commands) that the host computer can exercise when the terminal is on-line.

On-Line Operation

Before you can operate the terminal on-line, you must follow the steps of the power-up procedure described previously.

With these initial steps completed, the terminal is ready for communication with the host computer and its software. As discussed earlier in this chapter, the performance of the terminal is under control of the operating system and any other host software you are using. The host software documentation constitutes the primary source of terminal operating instructions.

To switch the terminal off-line, press CMD-ON LINE and the ON LINE lamp will turn off.

Off-Line Operation

Off-line, you can use the terminal as a training tool. From the keyboard, you can manually exercise the same terminal features and commands that the host computer can exercise when the terminal is on-

line. The following paragraphs provide general guidelines to off-line operation.

The descriptions of keyboard controls and indicators which appear later in this chapter define how the terminal responds off-line when the various keys are pressed. The D411/D461 programmer's reference manual contains all of the D411/D461 terminal commands. You can enter these commands from the keyboard by keying in the ASCII characters or character sequences for the associated commands.

In Data General operating mode, the terminal commands use some special ASCII characters that do not have corresponding keys on the keyboard. These characters fall in the range of <000> through <037>. Appendix A of the programmer's reference manual shows how to produce these characters from the keyboard. The <036> code is used extensively in the commands and can be produced from the keyboard only by pressing and holding down CMD while pressing BREAK ESC (CMD-BREAK ESC) with the terminal off-line.

Terminal commands in the ANSI operating mode also use characters not having corresponding keys on the keyboard and falling in the <000> through <036> range. However, these characters have completely different associated commands and are generally produced by using the CTRL key in conjunction with one of the main keypad keys. Appendix A of the programmer's reference manual also shows how to produce each of these characters.

The command-execution procedure that follows can be used to execute the terminal commands off-line. Off-line operation can be aborted in favor of on-line operation by pressing CMD-ON LINE at any point in the procedure. However, the environment established off-line (window and margin settings, etc.) will remain until reestablished by the host software.

Command Execution Procedure:

1. With the terminal off-line, enter a command using the keyboard. The command itself will not be displayed. (For example, the command "<036>F?3", which causes a Print Pass Through to be executed in Data General mode, does not itself appear on the screen.) The command executes as soon as it is completely entered at the keyboard.
2. Repeat step 1 for each command to be executed.

NOTE: *If you make an error entering a command, the command is ignored. Retype the command correctly.*

For a thorough example demonstrating the entry of terminal commands off-line, read the terminal off-line checkout and demonstration procedure in Chapter 2.

Keyboard Controls and Indicators

The U.S. keyboard is shown in Figure 3-2. It contains a typewriter-style, 60-key main keypad, a 12-key screen-management keypad, a 14-key numeric keypad, 15 user-function keys, and 5 local-function keys.

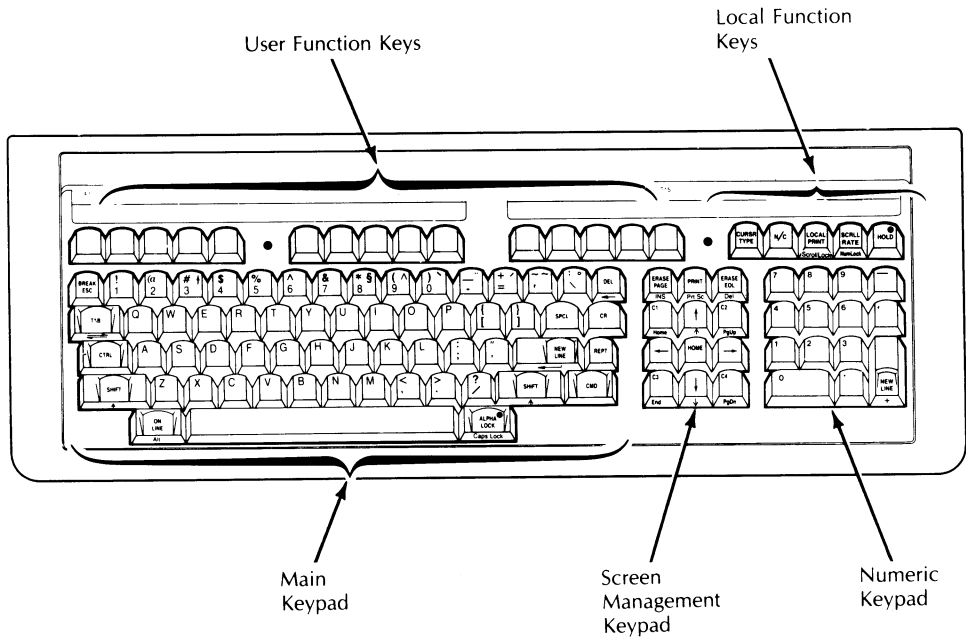

Figure 3-2. Terminal Keyboard

With the keyboard, you can generate all 95 displayable ASCII characters, the delete character, control characters, and numerous

special character sequences. Appendix A in the DASHER D411/D461 Display Terminal Programmer's Reference Manual lists all of these characters and character sequences along with codes generated by all keys.

The functions performed by code-generating keys in the on-line mode are controlled by software servicing the D411/D461 terminal in the host computer. The following paragraphs describe off-line operation of the code-generating keys, and operation of the keys that do not generate codes for the host computer. See the host system or application documentation for a description of on-line operation of the code-generating keys.

Two separate keyboard features are provided to speed the entry of repeated characters. One, typematic repeat, applies only to the lighter-colored keys on the keyboard. When one of these lighter-colored keys is pressed for more than three-quarters of a second, the associated character is generated at a rate of 15 characters per second until the key is released. Alternatively, pressing and holding down the REPT key along with any other character-generating key or key combination begins immediate repetition of the associated character at the rate of 30 characters per second. Repetition continues at that rate until either the REPT key is released, in which case the rules for typematic repeat begin to apply, or until the other key or combination is released, in which case the repetition ceases. The REPT feature also works for the NEW LINE key. However, the REPT key will not affect the operation of the CTRL, SHIFT, ON LINE, ALPHA LOCK, or CMD key sequences.

NOTE: *References made to lighter or darker keys in this and the following sections refer to the actual keyboard, not the keyboard figures.*

Main Keypad

The main keypad is shown in Figure 3-3. The lighter-colored keys on the main keypad form the standard typewriter-style keyboard. In the off-line state of the terminal, these keys produce the displayable characters shown on their keycaps.

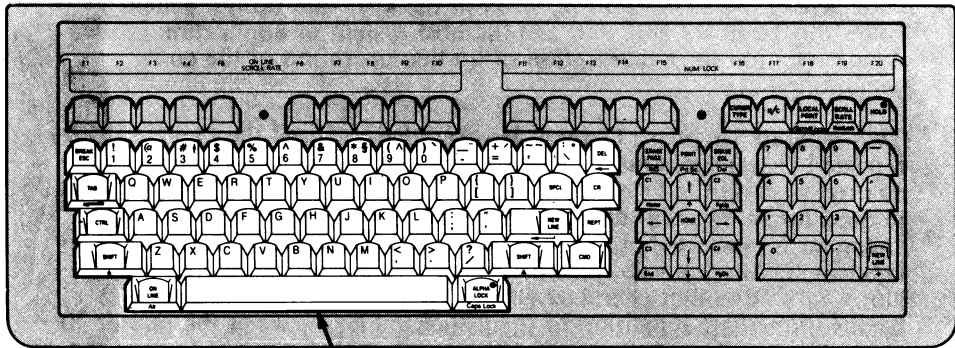

AA-0614

Figure 3-3. Main Keypad

NOTE: *Pressing the space bar or a display character key writes a space or display character to the alphanumeric-cursor location, deleting any previously displayed character in that location. Spacing over characters already typed erases those characters. The cursor-positioning keys can be used to move the cursor without the erasing action.*

The functions of the darker colored keys on the main keypad in the off-line state are:

- **BREAK ESC** — Pressing this key alone has no effect. In Data General mode, pressing the CMD key and then pressing ESC (CMD-ESC) generates the ASCII control code <036>.

When the terminal is on-line, pressing BREAK ESC and CMD simultaneously will generate a “break” condition (see Glossary).

In ANSI mode, pressing ESC and then pressing [generates the control code <CSI> (mnemonic for <233> in 8-bit mode or <033><133> in 7-bit mode).

The Data General <036> and ANSI <CSI> control codes are used extensively in programming the terminal, and the <036> code cannot be generated from the keyboard when the terminal is on-line in Data General mode. The <033><133> can be generated at any time.

NOTE: *In this manual, octal-based numbers are enclosed in angle brackets (<octal number>).*

- **TAB**—Pressing this key has no effect off-line (it generates <011>, an undefined control code).
- **CTRL**—Pressing this key alone has no effect. When you press and hold down CTRL while pressing another key, the control code of the other key is generated.
- **SHIFT**—Pressing this key alone has no effect. Pressing SHIFT while pressing another key generates the shift code of the other key (uppercase functions on the lighter keys of main keypad). If the ALPHA LOCK mode is on, this key has no effect on the alphabetic keys.
- **ON LINE**—Pressing this key alone has no effect. Pressing and holding down CMD while pressing ON LINE (CMD-ON LINE) switches the terminal between the on-line and off-line modes. The ON LINE lamp will light when the terminal is on-line, blink when the terminal is waiting to go on-line due to an incomplete connection to the host computer, and turn off when the terminal is off-line. When the terminal is powered up, it will attempt to go on-line automatically. As a result, the ON LINE lamp will either be on or blinking after power-up.
- **ALPHA LOCK**—This is an alternate action key that places all alphabetic keys in the uppercase mode the same way a shift-lock key does on a typewriter. ALPHA LOCK does not affect numeric or special symbol keys (except that on the French and Italian main keypads it does shift the 0 - 9 keys). The ALPHA LOCK lamp will light when the uppercase mode is in effect.
- **CMD**—Pressing this key alone has no effect. When you press CMD and hold it down while pressing another key, the command code of the other key will be generated.

- **REPT**—Pressing this key alone has no effect. Pressing REPT along with another code-generating key or key combination causes the code to repeat at a rate of 30 times a second. This key overrides the normal typematic feature of the keyboard. When the terminal is on-line and set to operate at less than 300 baud, the repeat rate is limited by the baud rate.
- **NEW LINE**—Pressing this key moves the cursor to the beginning of the next line (row). If the beginning of the next line is a protected character position, the cursor performs as many Cursor Right operations as needed until the first unprotected character position is reached. If the cursor is at the right margin of the last row of the window, the window is normally scrolled up one line, and the cursor moves to the left margin of the new bottom row. The roll enable/disable programming commands determine whether the window image scrolls up or the cursor moves to the left margin of the first row. If the cursor encounters a protected area when you press NEW LINE, the Cursor Right operation repeats as needed until the cursor reaches the first unprotected character position.

NOTE: *Pressing the NEW LINE key while pressing the REPT key repeats the new line function 30 times a second. If these two keys are pressed with smooth scrolling in effect, with the cursor on the bottom row of a window and with screen roll enabled, the cursor will disappear off the bottom of the window until the vertical scrolling caused by the repeating new line operation is complete.*

- **SPCL**—On the U.S. keyboard, pressing this key and then pressing certain sequences of other keys (see Table 3-1) results in one of the Data General International characters being displayed on the screen. Once you press the SPCL key and its complement, the special character will appear on the screen. If you enter a character that is not part of a valid sequence, the next key pressed will cause a character from the current active character set to be displayed rather than the special character desired. In that case, simply backspace one column and begin the correct sequence by pressing the SPCL key again.

NOTE: *The Katakana keyboard has no SPCL key and cannot generate European character sets.*

The particular characters shown in Table 3-1 are displayed regardless of the character set otherwise selected as active at the

time. This is true so long as the secondary character set (G1) contains the Data General International character set, which is the default G1 character set at power-up for Data General 8-bit and ANSI 7- and 8-bit modes. In Data General 7-bit mode, if the code generated by the SPCL key sequence indicates that a graphic character is present in the 7-bit code keyboard language, then that particular character is displayed. If no such graphic character is present in the keyboard language, then the terminal treats the sequence as invalid. The DASHER D411/D461 Programmer's Reference Manual contains detailed information about character-set selection.

NOTE: *Codes generated by keyboard nationalities other than the U.S. may differ. See Appendix F of the programmer's reference manual.*

Table 3-1. SPCL Key Sequences

Press SPCL Key		Character Displayed
Then Press	Then Press	
A	^	â (Â)
A	`	à (À)
A	..	ä (Ä)
A	'	á (Á)
A	~	ã (Ã)
A	•	å (Å)
e	^	ê (Ê)
e	`	è (È)
e	..	ë (Ë)
e	'	é (É)
i	^	î (Î)
i	`	ì (Ì)
i	..	ï (Ï)

Table 3-1. SPCL Key Sequences (continued)

Press SPCL Key		Character Displayed
Then Press	Then Press	
i	'	í (Í)
o	^	ô (Ô)
o	`	ò (Ò)
o	¨	ö (Ö)
o	'	ó (Ó)
o	~	õ (Õ)
o	/	ø (Ø)
u	^	û (Û)
u	`	ù (Ù)
u	¨	ü (Ü)
u	'	ú (Ú)
n	-	ñ (Ñ)
L		£
o	X	œ
space	^	^
space	¨	¨
space	'	'
space	`	`
space	~	~
space	•	•
a	e	æ (Æ)

Table 3-1. SPCL Key Sequences (continued)

Press SPCL Key		Character Displayed
Then Press	Then Press	
c	,	ç (Ç)
o	e	œ (Œ)
s	s	ß
c	/	¢
	(?)	(¿)
	(!)	(¡)
	↑	↑
	§	§

NOTE: *Parentheses indicate the character displayed when the SHIFT key is pressed and held down while the character is pressed. Keys that produce special character accents are identified by the symbols printed in the upper-right corners of the key faces. Once you press the SPCL key, the order in which you press the other keys does not matter.*

- **CR**—Pressing this key moves the cursor to the beginning of the current line. If the left-margin position contains a protected character, the cursor will move to the first unprotected character position to the right of the beginning of the line.
- **DEL**—Pressing this key has no effect off-line.

Screen-Management Keypad

The screen-management keypad shown in Figure 3-4 consists of ERASE PAGE, PRINT, ERASE EOL, HOME, and the cursor-positioning keys. These keys perform the following functions off-line.

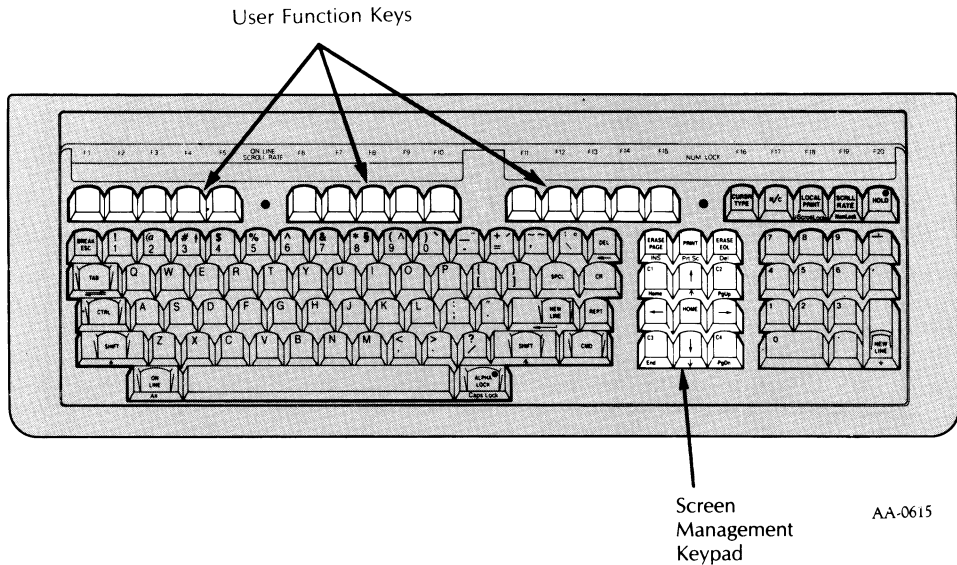

Figure 3-4. Screen-Management Keypad and User-Function Keys

- **ERASE PAGE**—Pressing this key clears the current window (window containing the cursor) of both protected and unprotected characters, and moves the cursor to the left margin of the top line of the window (window home position).

NOTE: *Terminal Reset*—When you press and hold down **CMD** while pressing **ERASE PAGE**, the terminal will reset to its initial power-on state and perform a self-test. You can reset it this way both off-line and on-line. Table 3-2 lists highlights of this reset operation.

Table 3-2. Terminal Reset Conditions

- Display screen cleared
- Cursor moved to upper-left corner of screen
- Cursor displayed as reverse-video block or according to selection made via the Terminal Configuration menu.
- Single window (24 rows) with margins at columns 0 and 79
- Primary character set: Keyboard nationality (7-bit mode), U.S. ASCII (8-bit mode)
- Normal character spacing selected
- Screen roll and horizontal scrolling enabled
- Character blinking enabled
- Character protection disabled
- Blink, dim, underscore, and reverse video turned off
- Line-drawing color set to solid green or amber (D461 only)
- User-defined characters deleted (D461 only)

- **PRINT**—Pressing this key has no effect off-line.
- **ERASE EOL**—Pressing this key erases characters from the current cursor position to the right margin (including the character in the cursor position). If any characters to the right of the cursor are protected, only those characters between the cursor and the first protected character are erased. The cursor position is not changed with this key.
- **➡ (Cursor Right)**—Pressing this key moves the cursor one column position to the right on the current row. If the cursor is at the right margin, it moves to the left margin of the next row; that is, a NEW LINE function is performed (refer to previous discussion of the NEW LINE key). If you attempt to move the cursor into a protected area, it will perform Cursor Right operations until it reaches the first unprotected character position.
- **⬅ (Cursor Left)**—Pressing this key moves the cursor one column position to the left on the current row. If the cursor is at the left

margin of a row, it moves to the right margin and, then, a Cursor Up operation takes place. If you attempt to move the cursor into a protected area, it will perform Cursor Left operations until it reaches the first unprotected character position.

- **↓ (Cursor Down)**—Pressing this key moves the cursor down one row in the current column. If the cursor is on the bottom row of a window, it moves to the top row of the window in the same column. If you attempt to move the cursor down into a protected area, it will perform Cursor Right operations until it reaches the first unprotected character position.
- **↑ (Cursor Up)**—Pressing this key moves the cursor up one row in the current column. If the cursor is on the top row of a window, it moves to the bottom row of the window in the same column. If you attempt to move the cursor up into a protected area, it will perform Cursor Left operations until it reaches the first unprotected character position.
- **HOME**—Pressing this key moves the cursor to the left margin of the first row in the current window. If the window home position is protected, the cursor will perform Cursor Right operations until it reaches the first unprotected character position.

User-Function Keys

The user-function keys are also shown in Figure 3-4. Keys F1 through F15, keys C1 through C4, PRINT, and the cursor-positioning keys can all be considered user-function keys. User-function keys have no effect in the off-line mode.

Numeric Keypad

The numeric keypad is shown in Figure 3-5. All of the keys on the numeric keypad are duplicated on the main keypad; their arrangement on the numeric keypad makes the entry of numbers easier.

Local-Function Keys

The local-function keys are also shown in Figure 3-5. These keys have the same effect whether the D411/D461 terminal is on-line or off-line. There are five local-function keys and one local-function lamp.

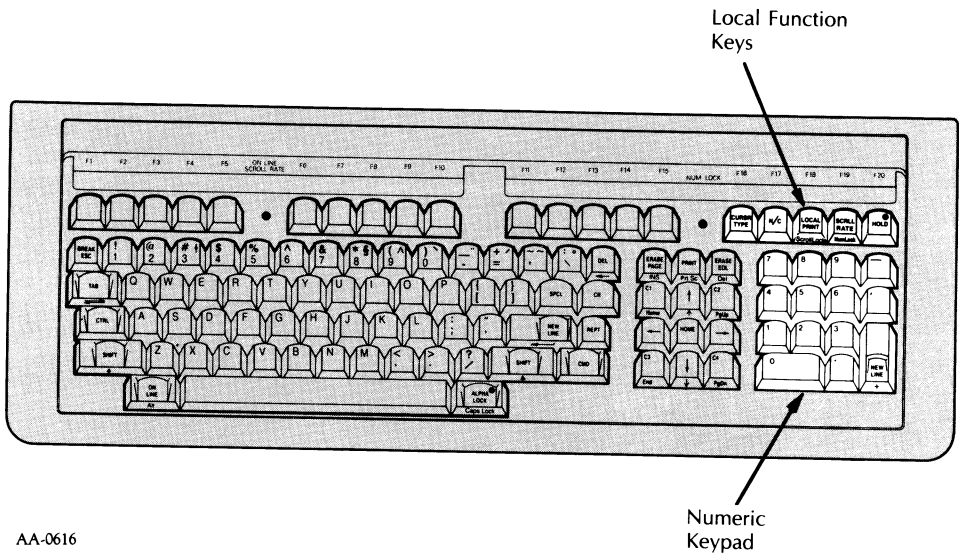

AA-0616

Figure 3-5. Numeric Keypad and Local-Function Keys

- CURSR TYPE**—Pressing this key changes the appearance of the cursor. When the terminal is turned on, the cursor is displayed as a reverse-video block. Pressing CURSR TYPE once causes the cursor to appear as a blinking underline. Subsequent depressions of CURSR TYPE cause the cursor to disappear, appear as a blinking reverse-video block, and return to its original form as a nonblinking reverse-video block.

The cursor appearance can also be changed with the Terminal Configuration menu. A selection of the cursor type made via the Terminal Configuration menu becomes effective only after power up or after reset (pressing the CMD and ERASE PAGE keys simultaneously.) Press the CMD and N/C keys to access the menu. After moving the cursor to the CURSOR TYPE in the left column, you can select reverse-video block, blinking underline, or blinking reverse-video block or none. Refer to Chapter 2 for

detailed instructions on how to use the Terminal Configuration menu.

- **N/C (Normal/Compressed)**—Pressing this key changes the appearance of the screen by switching between normal and compressed character spacing. When the terminal is turned on, there are 81 columns across the width of the display screen (normal spacing). When you press N/C once, the terminal displays 208 columns (compressed spacing). Subsequent depressions of N/C cause the appearance of the screen to alternate between the two spacing types. The margins are not affected by this key.

Pressing the CMD and N/C keys accesses the Terminal Configuration menu. To display the menu in English and override the native keyboard language, if other than English, press SHIFT-CMD-N/C.

- **LOCAL PRINT**—This key has no effect unless an operating printer is connected to the terminal.

Pressing the LOCAL PRINT key brings the Print menu up on your screen. If a printer is not hooked up to the terminal, the Print menu will not be displayed. The Print menu looks like the one in Figure 3-6.

Once the menu is called up on the screen, you can select the different print operations by pressing any numeric key or by using the cursor-positioning keys. If you press any other key while in the Print Menu, the words “Hit BREAK ESC Key to Exit” flash across the top of the menu. Pressing the BREAK ESC key allows you to exit the menu without initiating a print operation. After you’ve selected a print operation from the menu, press the NEW LINE key to exit the menu and start the selected print operation. To return to the menu, press LOCAL PRINT again. If you’re in a print operation and want to abort it, press LOCAL PRINT or press the CMD and CR keys simultaneously.

The selections on the Print menu are as follows:

1. **Print Screen**—The Print Screen operation is a local print operation. In other words, it can’t be initiated from the host. The Print Screen operation prints the entire contents of the screen. Print Screen ignores window boundaries. During printing, data entered at the keyboard is ignored and lost.

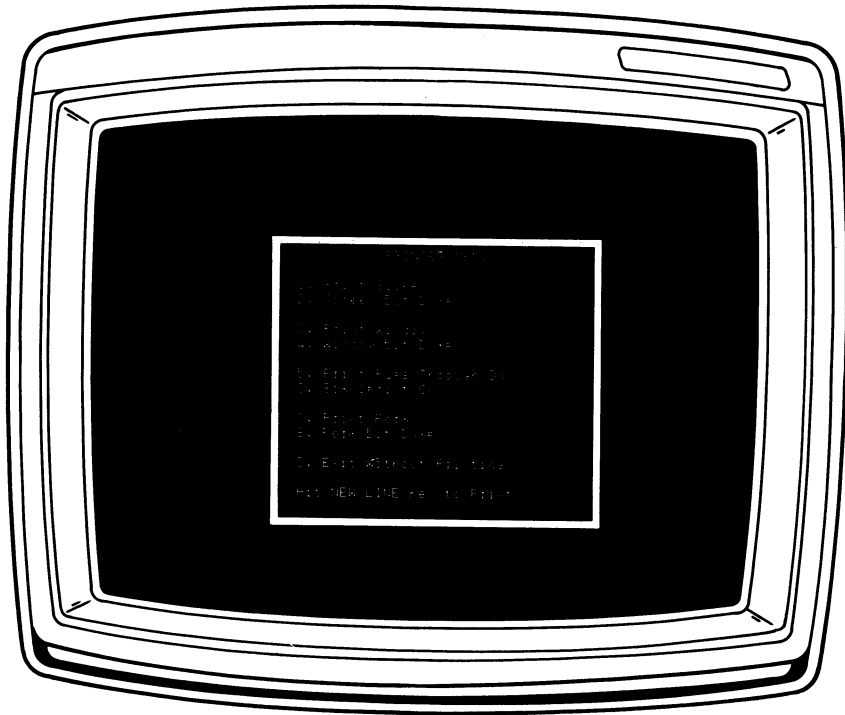

AA-0634

Figure 3-6. Print Menu

2. **Screen Bit Dump**—Screen Bit Dump is also a local print operation. In this operation, a bit image dump to the local graphics printer occurs. The screen contents are printed exactly as they appear on the screen except that underscore and blink attributes are ignored.
3. **Print Window**—In this operation, the contents of the current window are transmitted to the printer, beginning with the row containing the cursor. During printing, data entered at the keyboard is ignored and lost.

4. **Window Bit Dump**—In this operation, a bit image dump to the local graphics printer occurs. The active window is printed exactly as it appears on the screen except that underscore and blink attributes are ignored.
 5. **Print Pass Through On**—In this printing operation, all characters received from the host are sent to the printer without being displayed on the screen.
 6. **Simulprint On**—In this operation, all characters received from the host are sent to the printer and simultaneously displayed on the screen.
 7. **Print Form**—As long as protected text is disabled, data appearing at full intensity in the current window is printed. When protected text is enabled, only unprotected text (both normal intensity and dim) is printed.
 8. **Form Bit Dump**—This causes the graphics printer to print the active window exactly as it appears on the screen.
- **SCROLL RATE**—When the terminal is turned on, scrolling is performed in single-row increments (jump scrolling). Pressing SCROLL RATE will change the scroll rate for the current window to one of three settings:
 1. Pressing SCROLL RATE once enables smooth scrolling (performed at a rate of 5 character rows per second).
 2. Pressing SCROLL RATE a second time increases the smooth scroll rate to 10 character rows per second.
 3. Pressing it a third time returns the terminal to jump scrolling.

The scroll rate can also be changed with the Terminal Configuration menu. The selection of a scroll rate made via the Terminal Configuration menu becomes effective only after power up or after reset (pressing the CMD and ERASE PAGE keys simultaneously.) Press the CMD and N/C keys to access the menu. After moving the cursor to SCROLL RATE in the left column, you can select slow smooth scrolling, fast smooth scrolling or jump scrolling. Refer to Chapter 2 for detailed instructions on how to use the Terminal Configuration menu.

- **HOLD** — When the terminal is turned on, the **HOLD** lamp is off and the screen image is free to change. Pressing **HOLD** turns on the lamp and freezes the screen image, preventing it from changing. Keyboard operation may continue while the hold is in effect, but the characters typed will not be displayed. Pressing **HOLD** again unfreezes the screen, turns off the lamp, and causes any characters entered during the hold period to be displayed.

Mouse and Digitizer Operation

The D461 terminal (but not the D411) can use a mouse (Data General Model 4436) or digitizer (Data General Model 4437) to control the graphics cursor. Either of these optional devices may be attached to the printer/mouse/digitizer connector on the back of the terminal.

Once the mouse or digitizer is properly attached to the terminal, you must execute the **Cursor On** and **Cursor Track** commands to control the graphics cursor. (These are described in the DASHER D411/D461 Programmer's Reference Manual.) After the graphics cursor is on and tracking the device, you can move the device and the graphics cursor will move in a corresponding manner.

The mouse and digitizer each have three buttons. The buttons on the left and the right are user-function keys similar to the 15 function keys at the top of the terminal keyboard. When the terminal is on-line, these keys send a code sequence to the host. When off-line, these keys have no effect.

The middle button on both devices is a point key. When on-line, pressing this button will cause the terminal to send the location of the graphics cursor to the host computer. The format of this information is the same as that generated when the host computer issues the **Read Graphics Cursor** command. If the terminal is off-line, pressing this center button causes the location of the graphics cursor to be displayed on the screen.

The graphics cursor can also be controlled by the cursor-positioning keys on the terminal keyboard if the appropriate **Cursor Track** command is executed. The function of the middle button on the mouse or digitizer can be duplicated by pressing the **CURSR TYPE** key while holding down the **CMD** key. The codes sent by the other two buttons on the mouse and digitizer cannot be generated from the keyboard.

Downloading User-Defined Character Sets

This section contains general guidelines for loading user-defined characters in the D461 terminal. (User-defined characters are not a feature of the D411 terminal.)

The D461 terminal is equipped with a download capability that allows you to define a maximum of 3,572 custom characters at one time. These custom characters are in addition to the standard U.S. ASCII character set, the European ASCII character sets, and the word-processing, line-drawing, superscript/subscript, math, and Greek alphabet symbols that the D461 has in common with the D411 terminal.

User-created character sets normally exist in the form of one or more ASCII files or programs on the host computer system. The DASHER D411/D461 Programmer's Reference Manual describes in detail the programming commands involved in defining the custom characters. Every time power to the D461 terminal is cycled off and on, the following general steps must be followed to install the user-defined characters:

1. Power-up the terminal and log onto the host system as described in the power-up procedure earlier in this chapter.
2. Create or install the ASCII files or programs containing the custom characters on the host system.
3. Download (transfer) the custom characters from the host to the terminal. One way to do this is with the appropriate operating system command; for example, TYPE the files to the terminal when a Data General AOS or AOS/VS operating system is being used. A second download method might involve the host program automatically downloading custom characters as needed.

The operating system should signal that the download is complete by prompting you for input. The downloaded characters are now installed in the terminal and ready for use. The amount of time taken for a download of custom characters depends primarily on the number of characters downloaded and the baud-rate setting for the terminal/host connection. An approximate download time calculation can be performed as follows:

TIME = Total download time in seconds
 NO.CHAR = Number of character definitions to download
 CHAR-SEC = Character definitions downloaded per second
 BAUD = Host/terminal baud-rate setting
 BITS = Number of bits per ASCII character (including parity and start/stop bits)
 28 = Number of ASCII characters per character definition

If:

TIME = NO.CHAR/CHAR-SEC
 CHAR-SEC = BAUD/(BITS 28)

Then:

TIME = (NO.CHAR)(BITS)(28)/BAUD

Example:

If a set of 1,024 characters is downloaded at 9,600 baud, and each ASCII character transferred is assumed to consist of 10 bits (1 start bit, 7 data bits, 1 parity bit, and 1 stop bit), the total download time is calculated as follows:

$$\text{TIME} = (1,024 \times 10 \times 28) / 9,600 = 29.9 \text{ seconds}$$

This amounts to less than 3 seconds for each set of 94 characters.

Appendix A Display Screen Format and Coordinate System

DISPLAY SCREEN ROW/COLUMN FORMAT

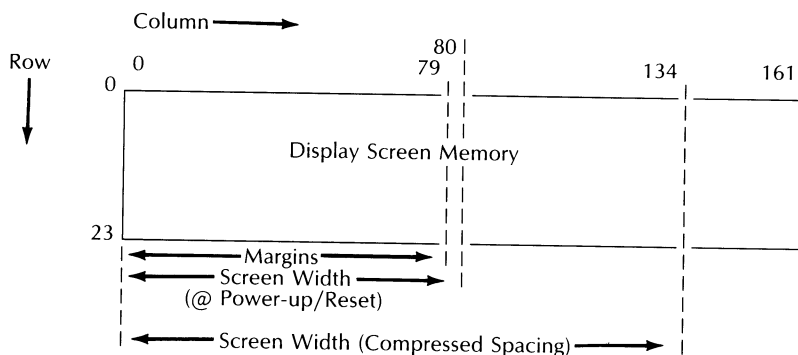

DISPLAY SCREEN COORDINATE SYSTEM

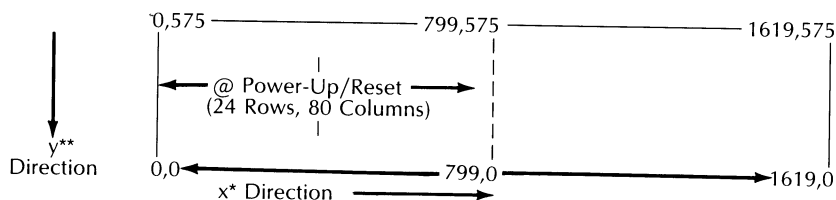

* 1-character column = 10 x-coordinate units

** 1-character row = 24 y-coordinate units

Appendix B

ASCII D411/D461 Code Sequences

This appendix lists the ASCII code sequences that can be generated by the D411/D461 terminal when operating in either Data General or ANSI Mode, and the keys that must be pressed to produce these sequences.

ASCII D411/D461 Code Sequences (Data General Operation)

The octal-code sequence for each of the keyboard combinations listed is $\langle 036 \rangle \langle A + B \rangle$. To find the octal value of $\langle A + B \rangle$, add the number at the top of the column in which a particular keyboard combination is located to the number in the far left column in the same row as the combination.

Example: The octal code sequence for CTRL-F8 is $\langle 036 \rangle \langle 070 \rangle$ ($\langle A + B \rangle = \langle 060 \rangle + \langle 010 \rangle = \langle 070 \rangle$).

NOTE: *In all keyboard sequences listed, the F or C key is pressed last. CTRL-SHIFT-F1 means press and hold down the CTRL key and the SHIFT key, and then press the F1 key.*

**Table B-1. ASCII D411/D461 Code Sequences
(Data General Operation)**

(B)	(A)	<040>	<060>	<130>	<150>	<170>
<000>		CTRL-SHIFT-F15	CTRL-F15	SHIFT-C1	SHIFT-F8	F8
<001>		CTRL-SHIFT-F1	CTRL-F1	SHIFT-C2	SHIFT-F9	F9
<002>		CTRL-SHIFT-F2	CTRL-F2	SHIFT-C3	SHIFT-F10	F10
<003>		CTRL-SHIFT-F3	CTRL-F3	SHIFT-C4	SHIFT-F11	F11
<004>		CTRL-SHIFT-F4	CTRL-F4	C1	SHIFT-F12	F12
<005>		CTRL-SHIFT-F5	CTRL-F5	C2	SHIFT-F13	F13
<006>		CTRL-SHIFT-F6	CTRL-F6	C3	SHIFT-F14	F14
<007>		CTRL-SHIFT-F7	CTRL-F7	C4		
<010>		CTRL-SHIFT-F8	CTRL-F8	SHIFT-F15	F15	
<011>		CTRL-SHIFT-F9	CTRL-F9	SHIFT-F1	F1	
<012>		CTRL-SHIFT-F10	CTRL-F10	SHIFT-F2	F2	
<013>		CTRL-SHIFT-F11	CTRL-F11	SHIFT-F3	F3	
<014>		CTRL-SHIFT-F12	CTRL-F12	SHIFT-F4	F4	
<015>		CTRL-SHIFT-F13	CTRL-F13	SHIFT-F5	F5	
<016>		CTRL-SHIFT-F14	CTRL-F14	SHIFT-F6	F6	
<017>				SHIFT-F7		

Additional Sequences:

Code Sequence	Keyboard
<036><001> <036><010>	CMD-SHIFT-PRINT SHIFT-HOME
<036><021> <036><027> <036><030> <036><031> <036><032>	CMD-PRINT SHIFT-↑ SHIFT-→ SHIFT-← SHIFT-↓

Codes generated by optional mouse or digitizer:

Code Sequence	Button Position
<036><157><137> <060><015>	Left
<036><157><174> <x-coordinate> <y-coordinate><015>	Center
<036><157><137> <061><015>	Right

ASCII D411/D461 Code Sequences (ANSI Operation)

The octal-code sequence for each of the keyboard combinations listed is <CSI><A><C><172>. The octal value of <A> is the number at the top of the column in which a particular keyboard combination is located. The octal values of <C>are the numbers in the far left column in the same row as the combination.

Example: The octal code sequence for CTRL-F8 (CF8)* is <CSI><062><060><070><172>(<A> = <062><C> = <060><070>).

NOTE: *In all keyboard sequences listed, the F or C key is pressed last. CTRL-SHIFT-F1 means press and hold down the CTRL key and the SHIFT key and then press the F1 key.*

Table B-2. ASCII D411/D461 Code Sequences (ANSI Operation)
Octal Code Sequence: <CSI><A><C><172>

(B)(C) ^(A)	<060>	<061>	<062>	<063>
<060><060>	F15	SHIFT-F15	CTRL-F15	CTRL-SHIFT-F15
<060><061>	F1	SHIFT-F1	CTRL-F1	CTRL-SHIFT-F1
<060><062>	F2	SHIFT-F2	CTRL-F2	CTRL-SHIFT-F2
<060><063>	F3	SHIFT-F3	CTRL-F3	CTRL-SHIFT-F3
<060><064>	F4	SHIFT-F4	CTRL-F4	CTRL-SHIFT-F4
<060><065>	F5	SHIFT-F5	CTRL-F5	CTRL-SHIFT-F5
<060><066>	F6	SHIFT-F6	CTRL-F6	CTRL-SHIFT-F6
<060><067>	F7	SHIFT-F7	CTRL-F7	CTRL-SHIFT-F7
<060><070>	F8	SHIFT-F8	CTRL-F8	CTRL-SHIFT-F8
<060><071>	F9	SHIFT-F9	CTRL-F9	CTRL-SHIFT-F9
<061><060>	F10	SHIFT-F10	CTRL-F10	CTRL-SHIFT-F10
<061><061>	F11	SHIFT-F11	CTRL-F11	CTRL-SHIFT-F11
<061><062>	F12	SHIFT-F12	CTRL-F12	CTRL-SHIFT-F12
<061><063>	F13	SHIFT-F13	CTRL-F13	CTRL-SHIFT-F13
<061><064>	F14	SHIFT-F14	CTRL-F14	CTRL-SHIFT-F14
<062><060>	C1	SHIFT-C1	CTRL-C1	CTRL-SHIFT-C1
<062><061>	C2	SHIFT-C2	CTRL-C2	CTRL-SHIFT-C2
<062><062>	C3	SHIFT-C3	CTRL-C3	CTRL-SHIFT-C3
<062><063>	C4	SHIFT-C4	CTRL-C4	CTRL-SHIFT-C4

Additional Sequences:

Code Sequence	Keyboard
<CSI><06><112>	Erase Page
<CSI><101>	Cursor Up
<CSI><102>	Cursor Down
<CSI><103>	Cursor Right
<CSI><104>	Cursor Left
<CSI><110>	Cursor Home
<CSI><151>	CMD-PRINT or CMD-SHIFT-PRINT
<CSI><013>	Erase EOL

Codes generated by optional mouse or digitizer:

Code Sequence	Button Position
<CSI><060><071> <060><172>	Left
<CSI><x-coordinate> <073 ><y-coordinate> <040><161>	Center
<CSI><060><071> <061><172>	Right

Appendix C

Summary of D411/D461 Commands

This appendix lists all of the D411/D461 commands and their respective ASCII code or code sequences in both alphabetical and octal-code order. The commands are divided into two sections: Data General Mode Commands and ANSI Mode Commands.

Table C-1. D411/D461 Commands in Alphabetical Order (DG Operation)

Command Name	Octal Form	Keyboard
Arc	<036><107><060><x><y> <radius><start><end>	<036>G0...
Bar	<036><107><061><x> <y><width><height><color> x, y, width, height = <NNN> color = ASCII character code	<036>G1...
Bell	<007>	CTRL-G
Blink Disable	<004>	CTRL-D
Blink Enable	<003>	CTRL-C
Blink Off	<017>	CTRL-O
Blink On	<016>	CTRL-N
Carriage Return	<015>	CTRL-M
Change Attributes	<036><106><116><char count> <set><reset> character count = <nnn> set, reset = <n>	<036>FN...
Cursor Down	<032>	CTRL-Z
Cursor Left	<031>	CTRL-Y
Cursor Off	<036><107><103>	<036>GC
Cursor On	<036><107><102>	<036>GB
Cursor Reset	<036><107><101>	<036>GA

Table C-1. D411/D461 Commands in Alphabetical Order (DG Operation) (continued)

Command Name	Octal Form	Keyboard
Cursor Right	<030>	CTRL-X
Cursor Track	<036><107><110><device>	<036>GH ...
	device = ASCII character code	
Cursor Up	<027>	CTRL-W
Define Character	<036><106><122><char> <row 0>...<row 9>	<036>FR...
	char = ASCII character code row 0, row 9 = <nn>	
Delete Character	<036><113>	<036>K
Delete Line	<036><106><111>	<036>FI
Delete Line Between Margins	<036><106><134>	<036>F\
Dim Off	<035>	CTRL-]
Dim On	<034>	CTRL-\
Display Character Generator Contents	<036><106><070>	<036>F8
Erase End-Of-Line	<013>	CTRL-K
Erase Screen	<036><106><105>	<036>FE
Erase Unprotected	<036><106><106>	<036>FF
Erase Window	<014>	CTRL-L
Fill Screen With Character	<036><106><076><char>	<036> F>char
	char = ASCII character code	
Fill Screen With Grid	<036><106><071>	<036>F9
Form Bit Dump	<036><106><077><066>	<036>F?6
Horizontal Scroll Disable	<036><106><135>	<036>F]
Horizontal Scroll Enable	<036><106><136>	<036>F^
Initialize Draw	<036><106><145><n><n>	<036>Fe <n><n>
Insert Character	<036><112>	<036>J
Insert Line	<036><106><110>	<036>FH
Insert Line Between Margins	<036><106><133>	<036>F[

Table C-1. D411/D461 Commands in Alphabetical Order (DG Operation) (continued)

Command Name	Octal Form	Keyboard
Line	<036><114><loc list> <null> or <036><107><070><loc list> <null> loc list = <x><y>...<x><y >x, y = <NNN>null = CTRL-SHIFT-@	<036>L... or <036>G8...
New Line	<012>	CTRL-J
Perform UART Loop-back Test	<036><106><074>	<036>F<
Print Form	<001>	CRTL-A or LOCAL PRINT and Menu
Polygon Fill	<036><107><072><loc list> <null>	<036>G:... or <036>G8...
Pop	<036><106><151>	<036>Fi
Print Pass Through Off	<036><106><077 ><062> or <036><106><141>	<036>F?2 or <036>Fa
Print Pass Through On	<036><106><077><063> or <036><106><140>	<036>F?3 <036>F'
Print Window	<021>	CRTL-Q or LOCAL PRINT and Menu
Protect Disable	<036><106><127>	<036>FW
Protect Enable	<036><106><126>	<036>FV
Protect Off	<036><106><115>	<036>FM
Protect On	<036><106><114>	<036>FL
Push	<036><106><150>	<036>Fh
Read Characters Remaining	<036><106><144>	<036>Fd
Read Cursor Attributes	<036><107><100>	<036>G@
Read Cursor Contents	<036><106><155><060>	<036>Fm0
Read Cursor Location	<036><107><077><174>	<036>G?l
Read Horizontal Scroll Offset	<036><106><117>	<036>FO
Read Model ID	<036><103>	<036>C
Read Screen Address	<036><106><142>	<036>Fb

Table C-1. D411/D461 Commands in Alphabetical Order (DG Operation) (continued)

Command Name	Octal Form	Keyboard
Read Window Address	<005>	CTRL-E
Reset	<036><106><101 >	<036>FA
Restore Normal Margins	<036><106><132>	<036>FZ
Reverse Video Off	<036><105>	<036>E
Reverse Video On	<036><104>	<036>D
Roll Disable	<023>	CTRL-S
Roll Enable	<022>	CTRL-R
Screen Home	<036><106><107>	<036>FG
Scroll Down	<036><111>	<036>I
Scroll Left	<036><106><103><column count>	<036>FC...
	column count = <nn>	
Scroll Right	<036><106><104><column count>	<036>FD...
	column count = <nn>	
Scroll Up	<036><110>	<036>H
Select ANSI Mode	<036><106><100>	<036>F@
Select Character Set	<036><106><123><set>	<036>FS...
	set = <nn>	
Select Compressed Spacing	<036><106><113>	<036>FK
Select Normal Spacing	<036><106><112>	<036>FJ
Select 7/8 Bit Operation	<036><106><125 ><mode>	<036>FU...
	mode = ASCII character code	
Set Alternate Margin	<036><106><131><row> <left margin><right margin>	<036>FY...
	row, left margin, right margin = <nn>	
Set Cursor Type	<036><106><121><type>	<036>FQ...
	type = ASCII character code	
Set Foreground Color	<036><101><color>	<036>A

Table C-1. D411/D461 Commands in Alphabetical Order (DG Operation) (continued)

Command Name	Octal Form	Keyboard
Set Keyboard Language	<036><106><146><language> language = ASCII character code	<036>Ff...
Set Margins	<036><106><130><left margin> <right margin> left margin, right margin = <nn>	<036>FX...
Set Pattern	<036><107><160><061> <offset><pattern definition> <null> pattern definition = <pattern character>...<pattern character>pattern character = ASCII character code null = CTRL-SHIFT-@	<036>Gpl
Set Scroll Rate	<036><106><124><rate> rate = ASCII character code	<036>FT...
Set Windows	<036><106><102><row count> <normal>...<row count> <normal> row count = <nn>normal = <n>	<036>FB...
Shift In	<036><117>	<036>O
Shift Out	<036><116>	<036>N
Show Columns	<036><106><137><left><right> left, right = <nn>	<036>F....
Simulprint Off	<036><106><077><060>	<036>F?0
Simulprint On	<036><106><077><061>	<036>F?1
Underscore Off	<025>	CTRL-U
Underscore On	<024>	CTRL-T
Window Bit Dump	<036><106><077><065>	<036>F?5
Window Home	<010>	CTRL-H
Write Cursor Location	<036><107><076><174> <x><y> x, y = <NNN>	<036> G>...

Table C-1. D411/D461 Commands in Alphabetical Order (DG Operation) (continued)

Command Name	Octal Form	Keyboard
Write Screen Address	<036><106><120><column> <row>	<036>FP...
Write Window Address	column, row = <nn> <020><column><row> column, row = <nn>	CTRL-P...

**Table C-2. D411/D461 Commands in Octal Code Order
(DG Operation)**

Octal Form	Command Name
<001>	Print Form
<003>	Blink Enable
<004>	Blink Disable
<005>	Read Window Address
<007>	Bell
<010>	Window Home
<012>	New Line
<013>	Erase End-Of-Line
<014>	Erase Window
<015>	Carriage Return
<016>	Blink On
<017>	Blink Off
<020><column><row>	Write Window Address
<021>	Print Window
<022>	Roll Enable
<023>	Roll Disable
<024>	Underscore On
<025>	Underscore Off
<027>	Cursor Up
<030>	Cursor Right
<031>	Cursor Left
<032>	Cursor Down
<034>	Dim On
<035>	Dim Off
<036><101><color>	Set Foreground Color
<036><103>	Read Model ID
<036><104>	Reverse Video On
<036><105>	Reverse Video Off

**Table C-2. D411/D461 Commands in Octal Code Order
(DG Operation) (continued)**

Octal Form	Command Name
<036><106><070>	Display Character Generator Contents
<036><106><074>	Perform Uart Loop-back Test
<036><106><071>	Fill Screen With Grid
<036><106><076><char>	Fill Screen With Character
<036><106><077><060>	Simulprint Off
<036><106><077><061>	Simulprint On
<036><106><077><062>	Print Pass Through Off
<036><106><077><063>	Print Pass Through On
<036><106><077><065>	Window Bit Dump
<036><106><077><066>	Form Bit Dump
<036><106><100>	Select ANSI Mode
<036><106><101>	Reset
<036><106><102><row count> <normal>...<row count><normal>	Set Windows
<036><106><103><columncount>	Scroll Left
<036><106><104><columncount>	Scroll Right
<036><106><105>	Erase Screen
<036><106><106>	Erase Unprotected
<036><106><107>	Screen Home
<036><106><110>	Insert Line
<036><106><111>	Delete Line
<036><106><112>	Select Normal Spacing
<036><106><113>	Select Compressed Spacing
<036><106><114>	Protect On
<036><106><115>	Protect Off
<036><106><116><character count> <set><reset>	Change Attributes
<036><106><117>	Read Horizontal Scroll Offset
<036><106><120><column><row>	Write Screen Address
<036><106><121><type>	Set Cursor Type

**Table C-2. D411/D461 Commands in Octal Code Order
(DG Operation) (continued)**

Octal Form	Command Name
<036><106><122><character> <row 0><row 9>	Define Character
<036><106><123><set>	Select Character Set
<036><106><124><rate>	Set Scroll Rate
<036><106><125><mode>	Select 7/8 Bit Operation
<036><106><126>	Protect Enable
<036><106><127>	Protect Disable
<036><106><130><left><right>	Set Margins
<036><106><131><row><left> <right>	Set Alternate Margins
<036><106><132>	Restore Normal Margins
<036><106><133>	Insert Line Between Margins
<036><106><134>	Delete Line Between Margins
<036><106><135>	Horizontal Scroll Disable
<036><106><136>	Horizontal Scroll Enable
<036><106><137><left><right>	Show Columns
<036><106><140>	Print Pass Through On
<036><106><141>	Print Pass Through Off
<036><106><142>	Read Screen Address
<036><106><144>	Read Characters Remaining
<036><106><145><set><number>	Initialize Draw
<036><106><146><language>	Set Keyboard Language
<036><106><150>	Push
<036><106><151 >	Pop
<036><106><155><060>	Read Cursor Contents
<036><107><060><x><y><radius> <start><end>	Arc
<036><107><061><x><y><width> <height><color>	Bar
<036><107><070><loc list><null>	Line
<036><107><072><loc list><null>	Polygon Fill

**Table C-2. D411/D461 Commands in Octal Code Order
(DG Operation) (continued)**

Octal Form	Command Name
<036><107><076><174><x><y>	Write Cursor Location
<036><107><077><174>	Read Cursor Location
<036><107><100>	Read Cursor Attributes
<036><107><101>	Cursor Reset
<036><107><102>	Cursor On
<036><107><103>	Cursor Off
<036><107><110><device>	Cursor Track
<036><107><160><061><offset> <pattern definition><null>	Set Pattern
<036><110>	Scroll Up
<036><111>	Scroll Down
<036><112>	Insert Character
<036><113>	Delete Character
<036><114><loc_list><null>	Line
<036><116>	Shift Out
<036><117>	Shift In

NOTE: *To generate <036> from the keyboard, press CMD-BREAK ESC.*

**Table C-3. D411/D461 Commands in Alphabetical Order
(ANSI Operation)**

Command Name	Octal Form	Keyboard
Arc	<CSI><loc><073 ><radius><073> <start><073><end><040><160>	<CSI>...;<040> p
Backspace	<010>	CTRL-H
Bar	<CSI><loc><073><width><073> <height><073><color><160>	<CSI>...;<040> p
Bell	<007>	CTRL-G
Carriage Return	<015>	CR or CTRL-M
Change Attributes	<CSI><count><073><on value> <073><off value><161>	<CSI>...;<040> q
Cursor Backward	<CSI><# of columns><104>	<CSI>...D
Cursor Down	<CSI><# of rows><102>	<CSI>...B
Cursor Forward	<CSI><# of columns><103>	<CSI>...C
Cursor Off	<CSI><040><165>	<CSI><040>u
Cursor On	<CSI><040><166>	<CSI><040>v
Cursor Position	<CSI><y><073><x><110>	<CSI>...;<040> H
Cursor Reset	<CSI><040><167>	<CSI><040>w
Cursor Track	<CSI><device><040><170>	<CSI>...<040>x
Cursor Up	<CSI><# of rows><101>	<CSI>...A
Define Character	<DCS><101><char><dd>...<dd> <ST>	<DCS>A...<ST>
Delete Character	<CSI><# of chars><120>	<CSI>...P
Delete Line	<CSI><# of rows><115>	<CSI>...M
Device Status Report	<CSI><066><156>	<CSI>n
End Protected Area	<033><127>	ESC-W
Erase In Display	<CSI><parm><112>	<CSI>...J
Erase In Line	<CSI><argument><113>	<CSI>...K
Form Feed	<014>	CTRL-L
Horizontal and Vertical Position	<CSI><row><073><col><146>	<CSI>...;<040> f

**Table C-3. D411/D461 Commands in Alphabetical Order
(ANSI Operation) (continued)**

Command Name	Octal Form	Keyboard
Index	<033><104>in 7-bit mode or <204> in 8-bit mode	ESC-D
Insert Character	<CSI><# of char><100>	<CSI>...@
Insert Line	<CSI><# of rows><114>	<CSI>...L
Line	<DCS><102><loc>...<loc><ST>	<DCS>B...<ST>
Media Copy	<CSI><value><151>	<CSI>...i
New Line	<012>	NEW LINE or CTRL-J
Next Line	<033><105>in 7-bit mode or <205> in 8-bit mode	ESC-E
Polygon Fill	<DCS><105><loc>..<loc><ST>	<DCS>E...<ST>
Pop	<CSI><040><175>	<CSI><040>}
Push	<CSI><040><174>	<CSI><040>
Read Cursor Attributes	<CSI><040><162>	<CSI><040>r
Read Cursor Contents	<CSI><060><040><176>	<CSI><040> <176>
Read Graphics Cursor	<CSI><040><161>	<CSI><040>q
Read Offset / Show Columns	Read offset: <CSI><060><164> and Show Columns: <CSI><061><073> <left col><073><right col><164>	Read offset: <CSI><060> Show Columns: <CSI>1;...;...t
Read / Reserve Characters	<CSI><061><073><set><073> <nnn><163>	<CSI>...;...s
Read Terminal Configuration	<CSI><170>	<CSI>x
Report Failures	<DCS><106><ST>	<DCS>F<ST>
Reset Mode	<CSI><mode><073><mode><073> ...<mode><154>	<CSI>...;...;...l
Reset To Initial State	<033><143> (7-bit mode only)	ESC-c
Reverse Index	<033><115> in 7-bit mode and <215> in 8-bit mode	ESC-M
Screen Position	<CSI><row><073><col><165>	<CSI>...;...u
Scroll Down	<CSI><# of rows><124>	<CSI>...T

**Table C-3. D411/D461 Commands in Alphabetical Order
(ANSI Operation) (continued)**

Command Name	Octal Form	Keyboard
Scroll Left	<CSI><# of col><040><100>	<CSI>...<040>@
Scroll Right	<CSI><# of col><040><101>	<CSI>...<040>A
Scroll Up	<CSI><# of rows><123>	<CSI>...S
Select Character Set	<033><designation><set>	BREAK ESC...
Select Graphic Rendition	<CSI><argument><073>Rendition <argument><073>...<argument> <155>	<CSI>...;...m
Set Margins	Main margins: <CSI><061><073><left margin><073><right margin><167>	<CSI>1;...;...w
	Alternate margins: <CSI><062><073><row><073><left margin><073><right margin><167>	<CSI>2;...;...;...w
	Return to main margins: <CSI><167> or <CSI><060><167>	<CSI>w
Set Mode	<CSI><mode><073>. ..<mode> <150>	<CSI>...;...h
Set Parameters	<CSI><parm><073><value><073>... <parm><073><value><166>	<CSI>...;...;...;...v
Set Pattern	<DCS><103><offset><pattern definition><ST>	<DCS>C...<ST>
Set Windows	<DCS><104><nn><n>...<nn><n> <ST>	<DCS>D...<ST>
Shift In	<017>	CTRL-O
Shift Out	<016>	CTRL-N
Single Shift Two	<033><116> in 7-bit mode or <216> in 8-bit mode	ESC-N
Single Shift Three	<033><117> in 7-bit mode or <217> in 8-bit mode	ESC-O
Start Protected Area	<033><126> in 7-bit mode or <226> in 8-bit mode	ESC-V
Write Graphics Cursor	<CSI><x-loc><073><y-loc><040> <164>	<CSI>...;...<040>t
Xoff	<023>	CTRL-S
Xon	<021>	CTRL-Q

**Table C-4. D411/D461 Commands in Octal Code Order
(ANSI Operation)**

Octal Form	Command Name
<001>	Print Form
<007>	Bell
<010>	Backspace
<012>	New Line
<014>	Form Feed
<015>	Carriage Return
<016>	Shift Out
<017>	Shift In
<021>	XON
<023>	XOFF
<033><designation><set>	Select Character Set
<033><104> in 7-bit mode	Index
<033><105> in 7-bit mode	Next Line
<033><115> in 7-bit mode	Reverse Index
<033><116> in 7-bit mode	Single Shift Two
<033><117> in 7-bit mode	Single Shift Three
<033><126> in 7-bit mode	Start Protected Area
<033><127>	End Protected Area
<033><143> (7-bit mode only)	Reset To Initial State
<204> in 8-bit mode	Index
<205> in 8-bit mode	Next Line
<215> in 8-bit mode	Reverse Index
<216> in 8-bit mode	Single Shift Two
<217> in 8-bit mode	Single Shift Three
<226> in 8-bit mode	Start Protected Area
<CSI><# of col><040><100>	Scroll Left
<CSI><# of col><040><101>	Scroll Right
<CSI><040><161>	Read Graphics Cursor

**Table C-4. D411/D461 Commands in Octal Code Order
(ANSI Operation) (continued)**

Octal Form	Command Name
<CSI><O40><162>	Read Cursor Attributes
<CSI><O40><165>	Cursor Off
<CSI><O40><166>	Cursor On
<CSI><O40><167>	Cursor Reset
<CSI><device><O40><170>	Cursor Track
<CSI><O40><174>	Push
<CSI><O40><175>	Pop
<CSI><O60><O40><176>	Read Cursor Contents
<CSI><O60><164>	Read Offset
<CSI><O60><167>	Set Margins (return to main margins)
<CSI><O61><O73><set><O73><nnn><163>	Read / Reserve Characters
<CSI><O61><O73><left col><O73><right col><164>	Show Columns
<CSI><O61><O73><left margin><O73><right margin><167>	Set Margins (main margins)
<CSI><O62><O73><row><O73><left margin><O73><right margin><167>	Set Margins (alternate margins)
<CSI><O66><156>	Device Status Report
<CSI><x-loc><O73><y-loc><O40><164>	Write Graphics Cursor
<CSI><loc><O73><radius><O73><start><O73><end><O40><160>	Arc
<CSI><loc><O73><width><O73><height><O73><color><160>	Bar
<CSI><parm><O73><value><O73>...<parm><O73><value><166>	Set Parameters
<CSI><mode><O73><mode><O73>...<mode><154>	Reset Mode
<CSI><argument><O73><argument><O73>...<argument><155>	Select Graphic Rendition
<CSI><count><O73><on value><O73><off value><161>	Change Attributes
<CSI><y><O73><x><110>	Cursor Position

**Table C-4. D411/D461 Commands in Octal Code Order
(ANSI Operation) (continued)**

Octal Form	Command Name
<CSI><row><073><col><146>	Horizontal and Vertical Position
<CSI><mode><073>...<mode><150>	Set Mode
<CSI><row><073><col><165>	Screen Position
<CSI><# of char><100>	Insert Character
<CSI><# of rows><101>	Cursor Up
<CSI><# of rows><102>	Cursor Down
<CSI><# of columns><103>	Cursor Forward
<CSI><# of columns><104>	Cursor Backward
<CSI><parm><112>	Erase In Display
<CSI><argument><113>	Erase In Line
<CSI><# of rows><114>	Insert Line
<CSI><# of rows><115>	Delete Line
<CSI><# of chars><120>	Delete Character
<CSI><# of rows><123>	Scroll Up
<CSI><# of rows><124>	Scroll Down
<CSI><value><151>	Media Copy
<CSI><167>	Set Margins (return to main margins)
<CSI><170>	Read Terminal Configuration
<DCS><101><char><dd>...<dd><ST>	Define Character
<DCS><102><loc>...<loc><ST>	Line
<DCS><103><offset><pattern definition><ST>	Set Pattern
<DCS><104><nn><n>...<nn><n><ST>	Set Windows
<DCS><105><loc>...<loc><ST>	Polygon Fill
<DCS><106><ST>	Report Failures

Appendix D

D411/D461 Argument Formats

Command/Argument Formats In Data General Mode

In Data General mode, each D411/D461 command consists of one or more ASCII control or display characters. Most of the arguments for the commands are represented by <n>, <nn>, and <nnn> for 1-, 2-, and 3-byte arguments, respectively. Only the lower 4 bits of each byte are used. The lower 4 bits are concatenated for multibyte arguments. The following table shows how to develop <n>, <nn>, and <nnn> argument values.

Table D-1. Command Argument Format (DG Mode)

ASCII Characters (0 to ?)	Argument Forms and Values (Decimal)			
	<n	<n n	<n> = 0 to 15 (decimal) <n> = 0 to 255 <n> = 0 to 4095	
0	0	0	0	
1	256	16	1	Examples:
2	512	32	2	
3	768	48	3	For <n> = 12
4	1024	64	4	= "<" (from table)
5	1280	80	5	
6	1536	96	6	For <nn> = 135 = 128+7
7	1792	112	7	1st n = 128 = "8"
8	2048	128	8	2nd n = 7 = "7"
9	2304	144	9	<nn> = "87"
:	2560	160	10	
;	2816	176	11	For <nnn> = 3888 = 3840+48+0
<	3072	192	12	1st n = 3840 = "?"
=	3328	208	13	2nd n = 48 = "3"
>	3584	224	14	3rd n = 0 = "0"
?	3840	240	15	<nnn> = "?30"

The following table shows how to develop a 3-byte argument for a graphics location coordinate (<NNN>, <xxx>, or <yyy>). The lower 5 bits are linked together to form a 3-byte argument.

Graphics Location/Height/Width Arguments

Table D-2. Graphics Location/Height/Width Arguments

ASCII Characters (@ to _)	<N	Argument Forms and Values (Decimal)	
	<x	N or x or y	N> x> y>
@	0	0	0
A	1024	32	1
B	2048	64	2
C	↑	96	3
D		128	4
E		160	5
F		192	6
G		224	7
H		256	8
I		288	9
J		320	10
K		352	11
L		384	12
M		416	13
N		448	14
O		480	15
P	512	16	
Q	544	17	
R	576	18	
S	608	19	
T	640	20	
U	672	21	
V	704	22	
W	736	23	
X	768	24	
Y	800	25	
Z	832	26	
[864	27	
\	896	28	
]	928	29	
^	960	30	
_	992	31	
	Not Used		

Examples:
 For <NNN><NNN>, <x>,<y> = 1358
 = 1024 + 320 + 14
 = "AJN"
 (from table)
 For <xxx><yyy> = 455
 = 0 + 448 + 7
 = "@NG"
 (from table)
 For <xxx>,<yyy>,<width>,<height> = 1420
 = 1024 + 348 + 12
 = "ALL"
 (from table)

Select Character Set Command Arguments

Table D-3. Select Character Set Command Arguments

Character Set	<set> DG	<set>ANSI
Keyboard	00	<060>
United States	01	<102>
United Kingdom	02	<101>
French	03	<122>
German	04	<113>
Swedish/Finnish	05	<110>
Spanish	06	<061>
Danish/Norwegian	07	<062>
Swiss	08	<063>
Katakana G0	09	<112>
Word Processing	10	<065>
Line Drawing	11	<066>
DG International	>	<064>
Katakana G1	0?	<111>

Command in Data General Mode: <036><106><123><set>

Command in ANSI Mode: GO - <033><050><set>

G1 - <033><051><set>

G2 - <033><052><set>

G3 - <033><053><set>

Appendix E

D411/D461 U.S. ASCII Functions and Conversion

To obtain the hexadecimal code for a U.S. ASCII character, add the number in the “hex” row at the top of the character’s column to the number in the “hex” column at the left of the character’s row.

Example: To arrive at the hexadecimal code for the “+” character, add $20 + B = 2B$ (base 16).

For the decimal code, follow the same procedure using the numbers in the “decimal” row and column.

Example: To arrive at the decimal code for the “@” character, add $64 + 1 = 65$ (base 10).

For the octal code, follow the same procedure using the numbers in the “octal” row and column.

Example: To arrive at the octal code for the “J” character, add $\langle 100 \rangle + \langle 012 \rangle = \langle 112 \rangle$ (base 8).

Table E-1. D411/D461 ASCII Functions and Conversion

H E X	D E C I M A L	O C T A L	20	30	40	50	60	70	Hex
			32	48	64	80	90	112	Decimal
			040	060	100	120	140	160	Octal
0	0	0	space	0	@	P	'	p	
1	1	001	!	1	A	Q	a	q	
2	2	002	"	2	B	R	b	r	
3	3	003	#	3	C	S	c	s	
4	4	004	\$	4	D	T	d	t	
5	5	005	%	5	E	U	e	u	
6	6	006	&	6	F	V	f	v	
7	7	007	'	7	G	W	g	w	
8	8	010	(8	H	X	h	x	
9	9	011)	9	I	Y	i	y	
A	10	012	'	:	J	Z	j	z	
B	11	013	+	;	K	[k	{	
C	12	014	(comma) ,	<	L	\	l		
D	13	015	(hyphen) -	=	M]	m	}	
E	14	016	.	>	N	^	n	~	
F	15	017		?	O	(underscore) _	o	UART Error	

Appendix F

D411/D461 ANSI Modes of Operation

Table F-1. D411/D461 Fixed ANSI Modes of Operation

Mode	<Code>	Fixed State
Keyboard Action	<062>	RESET
Control Representation	<063>	RESET
Status Reporting Transfer	<065>	RESET
Positioning Unit	<061><061>	RESET
Send-Receive	<061><062>	SET
Format Effector Action	<061><063>	RESET
Format Effector Transfer	<061><064>	RESET
Multiple Area Transfer	<061><065>	SET
Line Feed New Line	<062><060>	SET
Editing Boundary	<061><071>	RESET
Insertion-Replacement	<064>	RESET
Vertical Editing	<067>	RESET
Horizontal Editing	<061><060>	RESET
Selected Area Transfer	<061><067>	RESET
Tabulation Stop	<001><070>	RESET
Editing Boundary	<061><071>	RESET

NOTE: See ANSI X3.64 (1979).

Table F-2. D411/D461 Selectable ANSI Modes of Operation

Mode	<Code>	State	Effect
Roll Mode	<074><060>	SET RESET	Roll disabled Roll enabled
Blink Mode	<074><061>	SET RESET	Blink disabled Blink enabled
DG/ANSI Mode	<074><062>	SET RESET	ANSI mode Data General mode
Forms Mode	<074><064>	SET RESET	See Media Copy command. See Media Copy command.
Horizontal	<074><063>	SET Scroll RESET	Horizontal Scroll enabled RESET
Guarded Area	<061>	SET Transfer RESET	Protect attribute disabled RESET
Erasure Mode	<066>	SET RESET	Erase functions will erase protected text. Erase functions will not affect protected text.
Margins Mode	<074><065>	SET RESET	Editing within margins only Editing operations not limited by margins.

Glossary

ANSI American National Standards Institute, Inc., an organization that presents a standard coded character set used for information interchange among information processing systems, communications systems, and associated equipment.

ASCII American Standard Code for Information Interchange, one of the standards used to translate alphanumeric and control characters into binary numbers. The ASCII code assigns a unique binary number to each symbol (letters, digits, punctuation marks, etc.) and control character.

Alphanumeric A set of alphabetic, numeric, and other character symbols.

Argument An independent variable upon whose value the execution of a command depends. Some D411/461 commands include one or more arguments that combine with the command to define an action to be taken by the terminal.

Attribute For display terminals, an attribute is a characteristic associated with a character position on the display screen. For the D411/461 terminal, each character position can be programmed with five attributes: blink, dim, underscore, reverse video, and protect.

Baud The number of bits transmitted serially each second over a communication line.

Binary A numbering system with a radix of two; the two numerals used are 0 and 1.

Bit A binary digit with a value of either 0 or 1.

Break Condition The host computer transmit line is held low for a minimum of 100 milliseconds. On Data General DASHER terminals, the break condition is asserted as long as the BREAK ESC and CMD keys are simultaneously held down.

Buffer A temporary storage area for data; often used to compensate for the difference in data-handling capacities between a transmitting device and a receiving device.

Byte A group of 8 bits.

Cathode Ray Tube (CRT) A vacuum tube with a screen and a controlled beam of electrons; often used as a display device.

Character A member of a set of elements used to represent information. Characters are classified in groups such as alphabetical, numeric, special sign and symbol, and control characters that direct device operations.

Character code A combination of bits that represents a character in a character set.

Character set A collection of characters grouped together for a special purpose.

Command A string of characters that combine to direct a device operation. All D411/D461 terminal operations are controlled with the commands defined in the programmer's reference manual.

Cursor A visible marker on the screen indicating a position. The D411 terminal has an alphanumeric cursor, and the D461 has both an alphanumeric cursor and a graphics cursor. The alphanumeric cursor identifies the character position destined to hold the next character for display. For the D411 and D461 terminals, it may appear as a solid block, blinking block, blinking underscore, or invisible.

The graphics cursor on the D461 is a cross that indicates a picture element (pixel) position on the screen. This position may be read by the host computer under software control or transmitted to the host by the user. The graphics cursor is useful when running certain graphics software programs.

Data A general expression for the information that moves through a computer system or device.

Delimiter To establish the limits or bounds of something; some of the D411/D461 commands require delimiter characters to mark their end.

Dot matrix A rectangular pattern of dots used to form characters for display, also called a character cell. The characters for the D411/D461 terminal are all formed in a rectangular pattern that is 10 dots wide and 12 dots high (normal character spacing) or 12 dots wide and 12 dots high (compressed character spacing).

Download The process whereby data is transmitted from a host device and retained in a receiving device. For the D411/D461 terminal, the custom-character definitions can be transmitted from the host computer and retained in the terminal.

EIA Electronic Industries Association, an organization that establishes standards for electronic equipment.

Firmware Programming instructions retained in Read Only Memory (ROM) that can be executed by a computer just like software in Random Access Memory (RAM).

Full duplex A mode of serial data communication which takes place between two points in both directions simultaneously.

Graphics The science of communicating information with artwork, text, special symbols, etc. For the D411/D461 terminal, graphics refers to the display of artwork and text symbols with the aid of a host computer (computer graphics).

Hardware The physical equipment comprising the devices in a computer system.

Hexadecimal A numbering system with a radix of 16; the characters used to represent a hexadecimal number range from 0 to 9 and A to F.

Host Computer The computer controlling operation of a device such as the D411/D461 terminal.

Margins For the D411/D461 terminal, the margins define the columns between which the cursor is free to move. The margin settings (column numbers) are programmable and may define a column range running from 1 to 208.

Matrix A two-dimensional rectangular array organized into columns and rows.

Microprocessor An electronic component (or part) that contains all the circuits necessary to fetch and execute instructions in a program.

Monochrome A single color system; for the D411/D461 terminal, green or amber (depending upon the terminal model) is displayed on black.

Nibble A group of 4 bits.

Octal A numbering system with a radix of eight; the numerals used to represent an octal number range from 0 to 7. In this manual, octal numbers are enclosed in angle brackets (<octal number>).

Off-line The state of a device, such as the D411/D461 terminal, when it is not in communication with a host device.

On-line The state of a device when it is communicating with a host device.

Operating System The software resident in the host computer that controls the overall operation of the computer system.

Parity An extra bit that is added to the code for each character and is used for error detection. When odd parity is used, the parity bit is set so the number of binary 1s in a character is odd; for even parity, the parity bit is set to maintain an even number of 1s. Errors can be detected by checking for the correct count of 1s in a character.

Pixel A picture element or dot; the smallest element on the display screen that can be illuminated or darkened individually. For the D411/D461 terminal with normal character spacing in effect, there are 810 pixels across the width of the display screen; with compressed spacing, there are 1,215 pixels across the screen. In both cases there are 12 pixels for each character row (24 rows = 288 pixels).

Program A sequence of instructions or commands that are interpreted by a computer (or microprocessor) to control its operation and the operation of connected devices to perform a specific function.

Query A command issued by a device requesting selected information from another device. Several of the D411/D461 commands allow the host computer to request various types of status information from the terminal.

Raster scan A method of displaying information on a CRT. A raster scan consists of sweeping an electron beam across a display screen on a line-by-line basis, turning on pixels as required to create the desired image.

Read Only Memory (ROM) A type of computer memory that retains data written into it permanently. For the D411/D461 terminal, ROM is used to hold firmware that must remain intact when power is turned off.

Read/Write For the D411/D461 terminal, a type of memory that retains data written into it until power is turned off (volatile) or until new data is written over the old data.

Serial communication The process whereby bits are transmitted and received one at a time. On a communication line, a character consists of a string of bits and is not recognized at the receiving end until all of the bits have been received.

Software A collection of instructions (commands) and data that are interpreted and executed by a computer to control the hardware in a computer system. Software is a general term for all the binary data that can be manipulated in a computer system.

Terminal An input/output device that an operator can use to communicate with a computer system, usually in an interactive mode. The

D411/D461 terminal displays output data on its screen and accepts operator inputs through its keyboard.

UART Universal Asynchronous Receiver Transmitter; used to transmit and receive data serially. The UARTs in the D411/D461 terminal are responsible for communication with the host computer and optional printer.

Window For the D411/D461 terminal, a window consists of one or more consecutive character rows on the display screen. A window may contain from 1 to 24 rows; there may be from 1 to 24 windows on the display screen. The active window contains the cursor and has all the features of a full display screen.

Index

- Active window 1-4
- ALPHA LOCK key 3-9
- ASCII code sequences 1-16,
B-1, G-1
- ASCII functions and
conversion E-1

- Baud rate 1-15, 2-2, 2-12
- BREAK ESC key 3-8

- Character attributes 1-7
- Character sets 1-8
- Character spacing 1-5
- CMD key 3-9
- Code sequences ASCII B-1,
G-1
- Command execution
procedure 3-5
- Command header control
code 1-16
- Command syntax modes 1-2,
1-7
- Command/Argument
formats D-1
- Commands, Summary C-1
- Communication cabling 2-4
- Communication line 2-1
- Compressed spacing 1-5
- Control code 1-16, 3-9
- CR key 3-13
- CTRL key 3-9
- Cursor appearance 1-4
- Cursor Down key 3-16
- Cursor Left key 3-15
- Cursor positioning keys 3-15
- Cursor Right key 3-15
- CURSOR TYPE key 3-17
- Cursor Up key 3-16

- Data General International
character set 3-10
- Default terminal
configuration 2-12

- DEL key 3-13
- Digitizer 2-1
- Digitizer operation 3-21
- Display screen brightness
control 3-2
- Display screen coordinate
system A-1
- Display screen row/column
format A-1
- Display scrolling 1-5
- Display unit controls 3-1
- Display unit indicators 3-1
- Display-screen management
1-3
- Downline loadable character
set 1-2
- Downline loadable printed
circuit board 1-10
- Download time calculation
3-23
- Downloading 3-22
- Downloading character sets
3-22
- Downloading user-defined
character sets 3-22

- Editing functions 1-6
- ERASE EOL key 3-15
- ERASE PAGE key 3-14
- Erasing display characters 3-7
- Fast, smooth scrolling 1-5
- Foreign language character
sets 1-8
- Form bit dump print
operation 3-20
- Functions and conversion
ASCII E-1

- Graphics 1-10
- Graphics cursor 3-21
- Graphics cursor control 3-21
- Graphics cursor tracking
1-10

Graphics input devices 2-1
Greek alphabet symbols 3-22

HOLD key 3-21
HOME key 3-16
Horizontal scrolling 1-5
Host baud rate 2-12
Host data bit
communications 2-12
Host parity rate 2-12
Host terminal operating
mode 2-12

Installation 2-2
Installation site 2-1
Interface cabling 2-3
International characters 1-2

Jumpy scrolling 1-5

Key repetition 3-7
Keyboard configurations
1-17
Keyboard controls 3-6
Keyboard indicators 3-6
Keyboard nationalities 1-16,
3-11
Keypads 1-16

Line-drawing character set
1-8
Line-drawing symbols 3-22
LOCAL PRINT key 3-18
Local-function keys 3-16

Main keypad 1-17, 3-7
Maintenance 2-24
Margins 1-6
Math symbols 3-22
Menus for terminal
configuration setup 2-13
Model numbers 1-12
Modem 2-2
Modes of operation, ANSI
F-1
Mouse 2-1
Mouse operation 3-21

N/C key 3-18
NEW LINE key 3-10
Normal spacing 1-5
Numeric keypad 3-16

Off-line checkout 2-17, 2-23
Off-line operation 1-20, 3-4
Off-line printer checkout
2-23
Off-line state 1-19
ON LINE key 3-9
On-line checkout 2-23
On-line operation 1-18, 3-4
On-line state 1-18
Operational checkout 2-16

Power on/off control 3-1
Power on/off switch 3-1
Power-down procedure 3-3
Power-up procedure 3-3
Print form operation 3-20
PRINT key 3-15
Print methods 1-8
Print pass through 3-20
Print window 3-19
Printed circuit board 1-10
Printing operations 3-18
Programmable margins
feature 1-6
Protect attribute 1-6

Repacking 2-2
REPT key 3-10

Screen-management keypad
3-14
SCROLL RATE key 3-20
Scrolling 3-20
Self-test 1-18, 2-17
SHIFT key 3-9
Simulprint 3-20
Slow, smooth scrolling 1-5
Soft character set function
1-2
Space bar 3-8
SPCL key 3-10

- Special symbol character sets
1-10
- System operation overview
1-18
- TAB key 3-9
- Terminal and host computer
operation 1-19
- Terminal communication
options 2-11, 2-12
- Terminal configuration label
2-2
- Terminal configuration
menus 2-13

- Terminal frequency 2-12
- Terminal operating
procedures 3-4
- User-defined character sets
3-22
- User-function keys 3-16
- Vertical scrolling 1-5
- Window, active 1-4
- Window bit dump print
operation 3-20
- Windows 1-4

Technical Specifications (continued)

Display Unit Weight	7.3 kg (16.1 lb)
Keyboard Weight	2.6 kg (5.8 lb)
Cable Lengths:	
Keyboard Cable (extended)	1.2 m (4 ft)
Display Unit Power Cord	2.25 m (7.4 ft)
EIA, Modem, 20-mA Current Loop	6.1 m (25 ft) standard for all three cable types

Power

0 or 1 Power Suffix:

Voltage	90-132 Vac
Frequency	50 or 60 Hz +/- 1%
Current	3.0 amps peak at 90 Vac
Start-up Surge	22 amps at 120 Vac for 1/2 cycle

2 or 4 Power Suffix:

Voltage	187-264 Vac
Frequency	50 or 60 Hz +/- 1%
Current	2.4 amps peak at 187 Vac
Start-up Surge	11 amps at 240 Vac for 1/2 cycle

Environmental

Temperature Range	Operating: 10° to 38°C (50° to 100°F); Storage: 4° to 65°C (40° to 149°F)
Humidity Range	Operating: 20% to 80% noncondensing; Storage: 10% to 90% noncondensing
Altitude	Operating: Maximum 2,438 m (8,000 ft); Storage: Maximum 7,620 m (25,000 ft)
Radiation	Below 0.5 milliroentgens per hour (complies with FCC regulation Part 15, Subpart J, and CISPRES Part 16 for Class "A" computing devices)
Heat Output	50 watts or 170 BTU/hr.



Data General Corporation, Westboro, Massachusetts 01581



014-001161-01